



Thunder i860 S2603

User's Manual Revision 1.00

Copyright © Tyan Computer Corporation, 2001. All rights reserved. No part of this manual may be reproduced or translated without prior written consent from Tyan Computer Corp.

All registered and unregistered trademarks and company names contained in this manual are property of their respective owners including, but not limited to the following.

Tyan, Thunder i860 S2603 are trademarks of Tyan Computer Corporation.

Intel, Xeon, 860 chipset are trademarks of Intel Corporation.

Rambus is a trademark of Rambus Inc.

Phoenix, Phoenix BIOS are trademarks of Phoenix Software.

Microsoft, Windows are trademarks of Microsoft Corporation.

IBM, PC, AT, PS/2 are trademarks of IBM Corporation.

QLogic, Zircon are trademarks of QLogic Corporation.

Winbond is a trademark of Winbond Electronics Corporation.

National is a trademark of National Semiconductor Corporation.

Information contained in this document is furnished by Tyan Computer Corporation and has been reviewed for accuracy and reliability prior to printing. Tyan assumes no liability whatsoever, and disclaims any express or implied warranty, relating to sale and/or use of Tyan products including liability or warranties relating to fitness for a particular purpose or merchantability. Tyan retains the right to make changes to product descriptions and/or specifications at any time, without notice. In no event will Tyan be held liable for any direct or indirect, incidental or consequential damage, loss of use, loss of data or other malady resulting from errors or inaccuracies of information contained in this document.

Table of Contents

Chapter 1: Introduction	Page 4
1.1 Overview	4
1.2 Hardware Specifications	5
1.3 Software Specifications	6
1.4 Technical Support	7
1.5 Returning Merchandise for Service	7
Chapter 2: Board Installation	8
2.1 Unpacking	8
2.2 Installation	8
2.3 How to install our products right... the first time	8
2.4 Quick Reference for Jumpers	10
2.5 Map of Motherboard Jumpers	11
2.6 Setting up Jumpers and Onboard Connectors	12
2.6-A Front Panel Connector	12
2.6-B CMOS Reset	12
2.6-C BIOS Boot Block	13
2.6-D DIP Switch	13
2.6-E Onboard LAN Enable/Disable	14
2.6-F Onboard SCSI Enable/Disable	14
2.6-G Speaker Connector	15
2.6-H PCI Speed Select	15
2.6-I FAN Connectors	16
2.6-J Soft Power Connector	16
2.6-K Hardware Reset Switch Connector Installation	16
2.6-L Flash Utility	16
2.7 Mounting the Motherboard in the Chassis	17
2.8 Installing Memory	18
2.9 Installing the CPU and Cooling Fan(s)	23
2.10 Connecting IDE and Floppy Drives	25
2.11 Installing Add-on Cards	27
About the AGP Pro slot	28
2.12 Connecting PS/2, USB, and Serial Devices	29
2.13 Connecting the Power Supply	30
2.14 Frequently Asked Questions (FAQ)	32
Chapter 3: BIOS Setup	33
Introduction to the BIOS Setup	33
Starting Setup	33
Setup Keys	34
Getting Help	34
In Case of Problems	34
Setup Variations	34

3.1	Main Setup	35
3.2	Advanced Setup	36
3.2-A	Processors screen	36
3.2-B	Chipset screen	37
3.2-C	Floppy Disk Drive screen	37
3.2-D	IDE Devices screen	38
3.2-E	Integrated SCSI screen	40
3.2-F	Integrated Network screen	40
3.2-G	Integrated I/O Ports screen	41
3.2-H	Integrated Audio screen	42
3.2-I	AGP Slot (Graphics) screen	42
3.2-J	PCI Device, Slot #1 (...2, 3, 4, 5) screen	43
3.3	Security Setup	43
3.4	Power Setup	45
3.5	Boot Setup	45
3.6	Exit Setup	46
Chapter 4: System Resources		47
4.1	Beep Codes	47
4.2	Flash Utility	47
Appendix I: SCSI Installation and LAN Information		48
	Introduction	48
	Features of the LSI Symbios SCSI BIOS	48
	Legacy Support for non-Ultra160 SCSI devices	48
	Setting up internal SCSI peripherals	48
	Checking SCSI IDs	48
	Terminating SCSI devices	48
	Connecting SCSI Peripherals	48
	Connecting internal cables for Ultra160 LVD SCSI devices	48
	Information on the LSI Symbios 53C1010 SCSI BIOS	50
	Boot Initialization with BIOS Boot Specification (BBS)	50
	CD-ROM Boot Initialization	50
	Starting the SCSI BIOS Configuration Utility	50
	Error Messages	51
	Using the Configuration Utility	51
	Main Menu	52
	Boot Adapter List	53
	Global Properties	54
	Adapter Properties	55
	Device Properties	57
	Quitting the SCSI BIOS Configuration Utility	58
	LAN Information	59
Appendix II: Glossary		60

Chapter 1: Introduction

1.1 Congratulations!

You are now the proud owner of the premier dual Intel® Xeon™ platform!

The Thunder i860™ is a high performance workstation platform designed for applications that require the power of dual Intel® Xeon™ processors. This platform utilizes the Intel 860 chipset and can support CPU speeds through 1.7+GHz* and front side bus speeds of 100 MHz or 133 MHz. Please see Tyan's website for updates and information concerning CPU information and support:

<http://www.tyan.com>

This integrated performance board is supported in an Extended ATX form factor. Some of the features included are onboard UltraDMA-100/66/33 support, and an Intel 82550 10/100 LAN controller.

With I/O and drive controller support onboard, the one 4X AGP Pro 50 slot, three 32-bit/33MHz PCI slots, and two 64/32-bit 66/33MHz PCI slots are free for numerous types of add-on expansion cards. The use of a separate Memory Expansion Card (MEC) allows for memory expansion options.

Remember to visit Tyan's website at **<http://www.tyan.com>**. There you can find information on all of Tyan's products with FAQs, distributors list, and BIOS settings explanations.

NOTE: Due to its extremely powerful processing capabilities, the Thunder i860 requires a specialized dual Xeon-capable, APPROVED* power supply. Also, a Memory Expansion Card (MEC) is required to harness the complete Rambus memory performance potential.

* not verified at time of print, check the Tyan website for updates: **<http://www.tyan.com>**

1.2 Hardware Specifications

Processor Information	Dual PGA603 ZIF sockets Supports dual Intel Xeon processors One onboard VRM 400MHz system bus support
Expansion Slots	One 4X AGP Pro 50 slot supports 2x/4x modes Three 32-bit 33MHz PCI slots Two 64/32-bit 66/33MHz 3.3V PCI slots Total of six usable slots
Chipset Information	Intel 860 chipset MCH+ICH2+FWH National PC87366 Super I/O ASIC
Hardware Monitoring	Winbond 83782D hardware monitoring chip 3-pin fan monitoring headers CPU temperature and voltage monitoring
Memory	Eight 168-pin Rambus RIMM sockets (on MEC) Supports up to 2GB* PC800 Registered RDRAM Supports ECC (72-bit) memory modules
Integrated I/O	One floppy connector supports up to two drives Two 9-pin 16550-based serial ports One 25-pin SPP/ECP/EPP parallel port Two USB ports PS/2 keyboard and mouse ports
Integrated PCI IDE	Dual-channel master mode Up to four Enhanced IDE devices Support for UltraDMA-100/66/33 IDE and ATAPI compliant devices
Integrated LAN	Intel 82550 LAN controller 10/100 Mbps data transfer rate capability
Integrated SCSI (manufacturing option)	LSI Symbios 53C1010R controller Dual-channel Ultra160 SCSI support 160Mbps maximum data throughput Supports up to 15 LVD SCSI devices per channel Channels 1 & 2: 68-pin connector each
Integrated Audio (manufacturing option)	AD1885 chipset AC'97 codec Line-in, line-out, and mic-in ports

* Not validated at time of print, please check Tyan website for memory compatibility information:
<http://www.tyan.com>

BIOS

Phoenix BIOS 2 Mbit Flash
Supports APM 1.2 & ACPI 1.0
Auto-configuration of IDE hard disk types
Multiple boot options
DMI 2.0 compliant

Form Factor

Ext. ATX 12" x 13" (304.80mm x 330.20mm)
One 24-pin and one 8-pin power connector
Stacked mouse & keyboard ports
Stacked two USB ports
Stacked one parallel and two serial ports
One RJ-45 LAN port with LEDs

Regulatory

FCC Class B (Declaration of Conformity)
European Community CE (Declaration of Conformity)

1.3 Software Specifications

OS

Windows NT/2000

1.4 Technical Support

If a problem arises with your system, you should turn to your dealer for help first. Your system has most likely been configured by them, and they should have the best idea of what hardware and software your system contains. Hence, they should be of the most assistance. Furthermore, if you purchased your system from a dealer near you, you can actually bring your system to them to have it serviced, instead of attempting to do so yourself (which can have expensive consequences).

Help Resources:

1. See the FAQ and beep codes section of this manual.
2. See the Tyan website for FAQ, bulletins, driver updates, and other information: <http://www.tyan.com>
3. Contact your dealer for help **BEFORE** calling Tyan.
4. Check the Tyan user group: alt.comp.periphs.mainboard.tyan

1.5 Returning Merchandise for Service











During the warranty period, contact your distributor or system vendor **FIRST** for any product problems. This warranty only covers normal customer use and does not cover damages incurred during shipping or failure due to the alteration, misuse, abuse, or improper maintenance of products.

NOTE: A receipt or copy of your invoice marked with the date of purchase is required before any warranty service can be rendered. You may obtain service by calling the manufacturer for a Return Merchandise Authorization (RMA) number. The RMA number should be prominently displayed on the outside of the shipping carton and the package should be mailed prepaid. Tyan will pay to have the board shipped back to you.

Chapter 2: Board Installation

2.1 Unpacking

The retail motherboard package should contain the following:

-  Thunder i860 motherboard
-  Memory Expansion Card (MEC)
-  (2) Continuity RIMMs
-  34-pin floppy cable
-  UltraDMA-100/66/33 IDE cable
-  68-pin Ultra160 LVD SCSI cable
-  I/O shield*
-  Thunder i860 user's manual
-  Tyan driver CD
-  (2) LSI SYM1010 SCSI Driver Disks

2.2 Installation

You are now ready to install your motherboard. The mounting hole pattern of the motherboard matches the ATX board specifications, so your chassis must be capable of supporting an Extended ATX board (check the motherboard dimensions provided on **p. 6**).

2.3 How to install our products right.. the first time.

Question: what's the first thing I should do?

The first thing you should do is read the user's manual. It contains important information which will make configuration and setup much easier, as well as provide information on device installation and component set up. By reading through the manual completely before installing your motherboard, you will have a complete overview on the installation.

* if you require a different I/O shield solution, please contact your chassis vendor

Here are some safety tips:

- (1) **Ground yourself properly before removing your motherboard from the antistatic bag.** Unplug the power from your computer power supply and touch any metal part on the computer case. (You might also want to wear a grounded wrist strap.)
- (2) **Hold the motherboard by its edges and do not touch the bottom of the board.**
- (3) **Avoid touching motherboard components, IC chips, connectors, and leads.**
- (4) **Avoid touching pins of memory modules and chips.**
- (5) **Place motherboard on a grounded antistatic surface or on the antistatic bag.**

Having reviewed the precautions above, the next step is to take the motherboard out of the cardboard box and static bag, hold it by its edges, and place it on a grounded antistatic surface, component side up. Inspect the board for damage.

NOTE:**DO NOT APPLY POWER TO THE BOARD IF IT HAS BEEN DAMAGED!**

Press down on any of the socketed ICs if it appears that they are not properly seated (the board should still be on an antistatic mat). Do not touch the bottom of the board. Remember, don't take any electronic device out of its protective bag until you are ready to actually install it into the computer case. If you do not ground yourself, you risk zapping the motherboard or adapter card. Subsequent problems may not arise immediately because electrostatic discharge, unlike physical damage, causes the device to fail over time.

2.4 Quick References for Jumpers

In this manual, the term “closed” and “on” are used when referring to jumpers (or jumper pins) that are active; “open” and “off” are used when referring to jumpers (or jumper pins) that are inactive. See **Figure 2.0a** and **Figure 2.0c** for examples of “on” and “off” pins and jumpers.

Jumpers and pins are connected by slipping the plastic jumper connector over the top of two adjacent jumper pins (indicated by 1-2 or 2-3). The metal rod inside the plastic shell bridges the gap between the two pins, completing the circuit. See **Figure 2.0b** and **Figure 2.0d** for more examples of 3-pin jumper connections. NOTE: The small number “1” indicates pin 1.

The tables and maps on the following pages will help you set the jumpers for CPU speed, infrared, and external connector pin assignments, among others. The miniature motherboard maps will help you locate the jumpers on your board. Full page maps of the motherboard can be found on the next two pages.

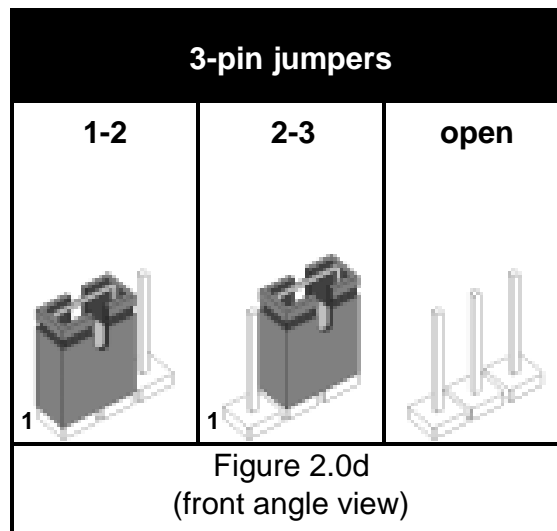
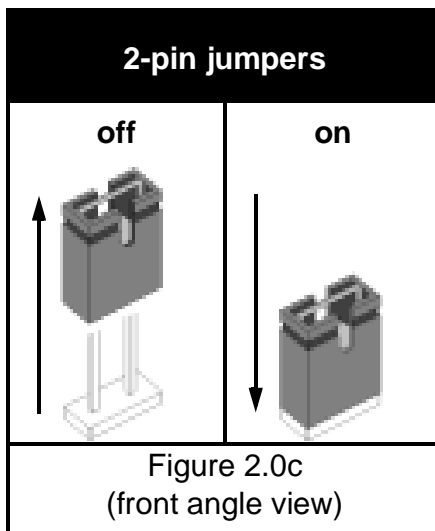
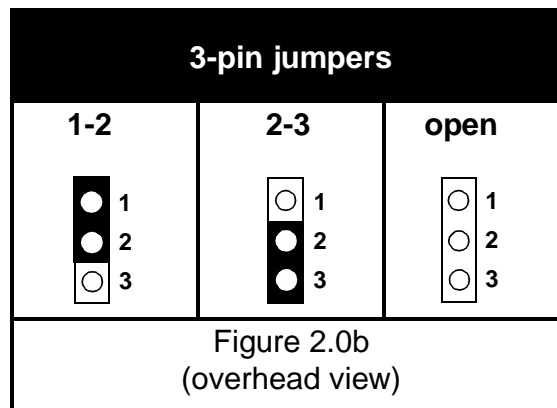
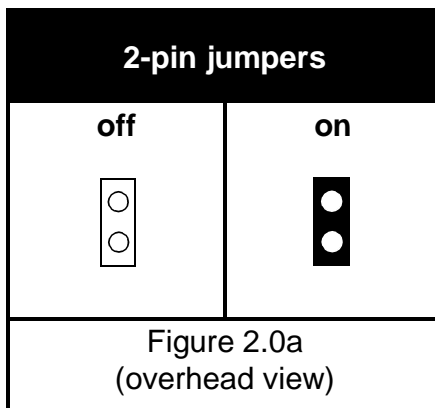

2.5 Map of Motherboard Jumpers

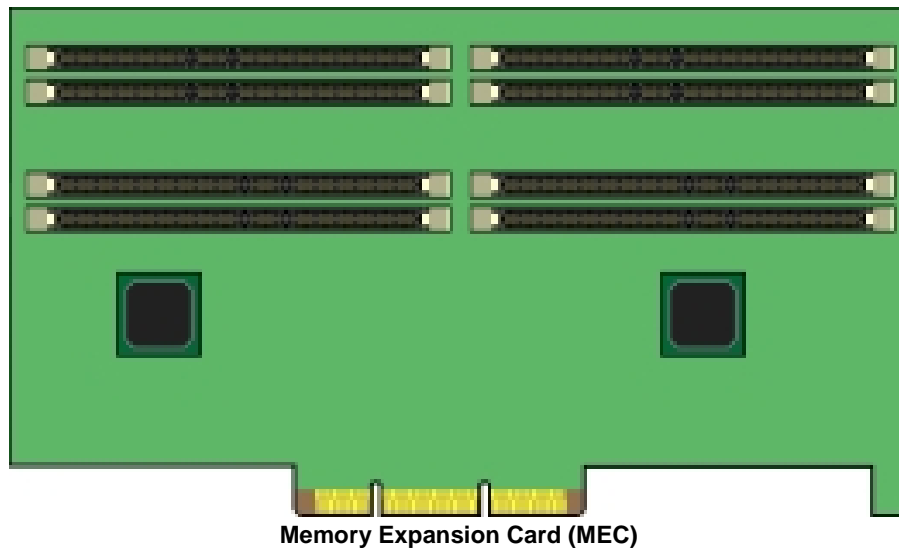
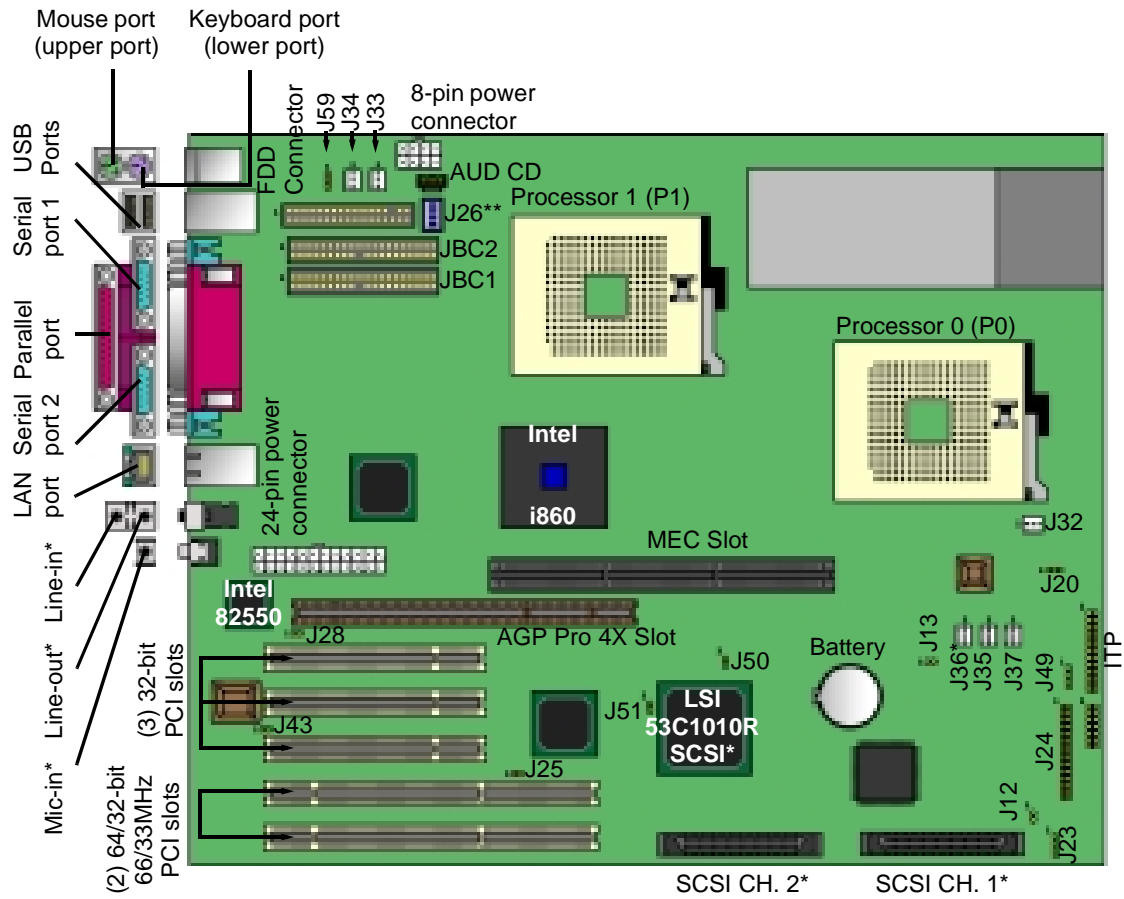

* indicates an optional feature available on some Thunder i860 models

** J26 (dip switch), if present on the Thunder i860, must always have positions 1 through 4 switched to "OFF" (in the bottom position). Details on **p.13**.

2.6 Setting up Jumpers and Onboard Connectors

Pinouts for certain connectors are available on the Tyan website: <http://www.tyan.com>

A. Front Panel Connector (J24)

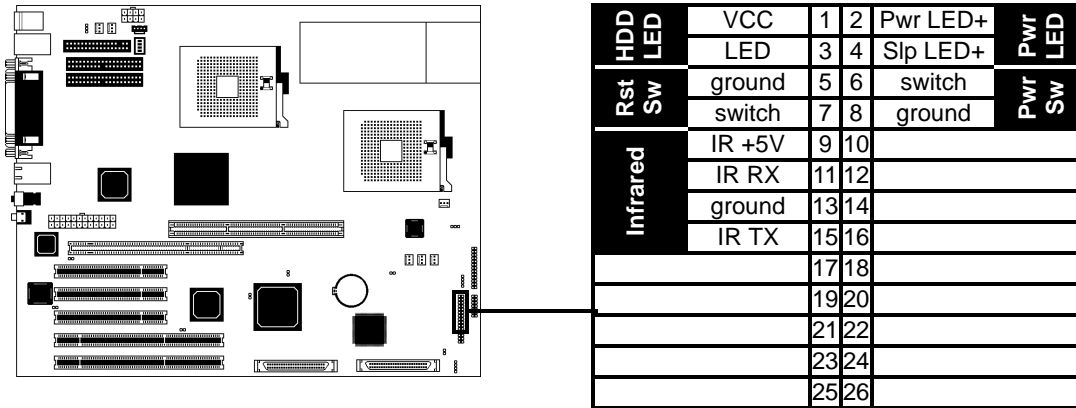

Your chassis will usually come with connectors to install onto the motherboard, such as HDD and Power LEDs. The Front Panel Connector has been implemented for such purposes.

VCC	27	28	LED
LAN LED			

Abbreviations		
Rst	→	Reset
Pwr	→	Power
Slp	→	Sleep

B. CMOS Reset (Battery)

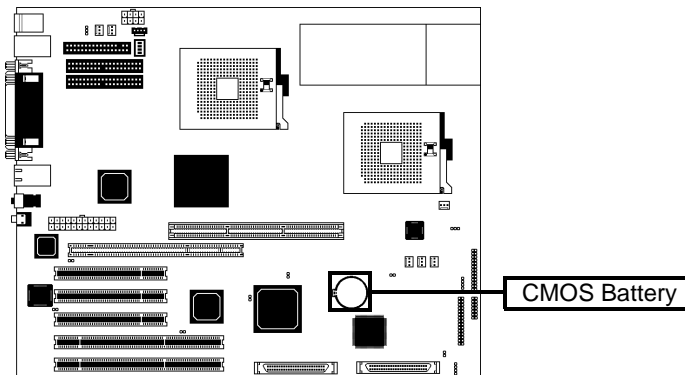

If you have been locked out of your system because you forgot your password or set the CMOS incorrectly, or have just finished flashing your BIOS follow the instructions below.

1. Power off the system, and disconnect the power supply
2. Pop out (uninstall) the battery by pressing on the rear latch
3. Wait about FIVE seconds
4. Re-install the battery, then power on the system again

By following this procedure, you will erase your password and reset the CMOS.

C. BIOS Boot Block (J43)

In case there is an error during flashing, the BIOS Boot Block provides a protection feature for the BIOS.

NOTE:	DO NOT alter this jumper unless you are absolutely sure you fully understand this jumper's effects on your system.
	Tyan takes no responsibility and will not be held liable for damage related to alteration of this jumper from its factory-set default. Default is OPEN.

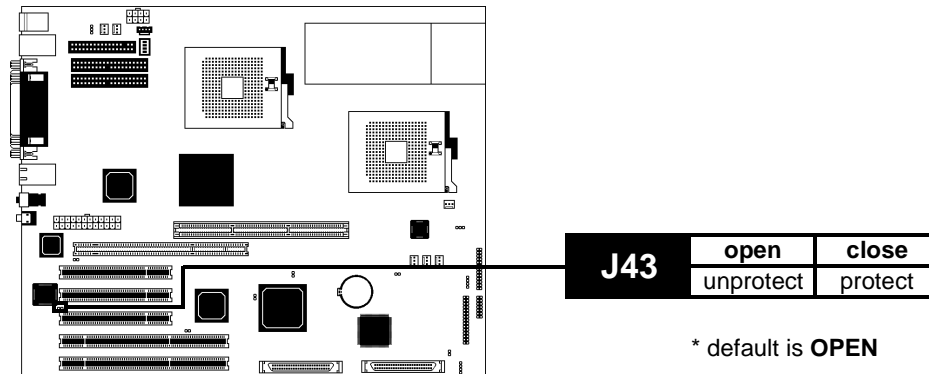

D. DIP Switch (J26) (optional)

This is a DIP switch for internal purposes. If present on the Thunder i860, please make sure that ALL switches must always have positions 1 through 4 switched to "OFF" (in the bottom position).

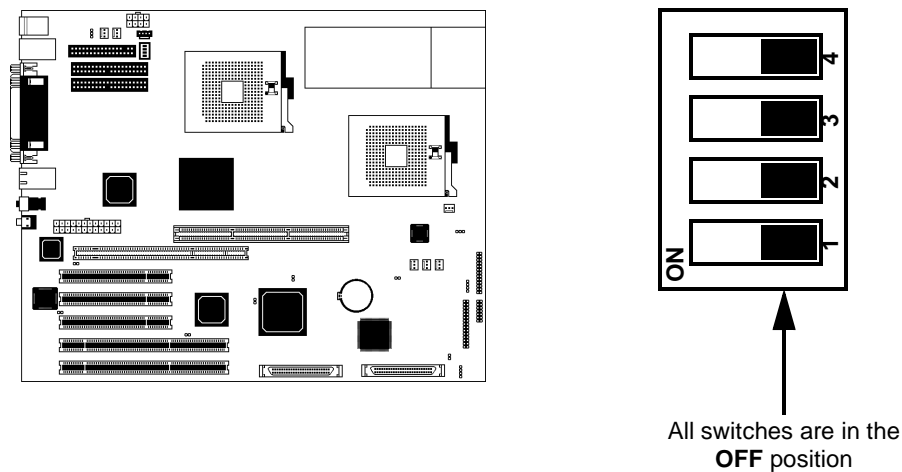

E. Onboard LAN Enable/Disable (J28)

This jumper can disable the onboard LAN port.

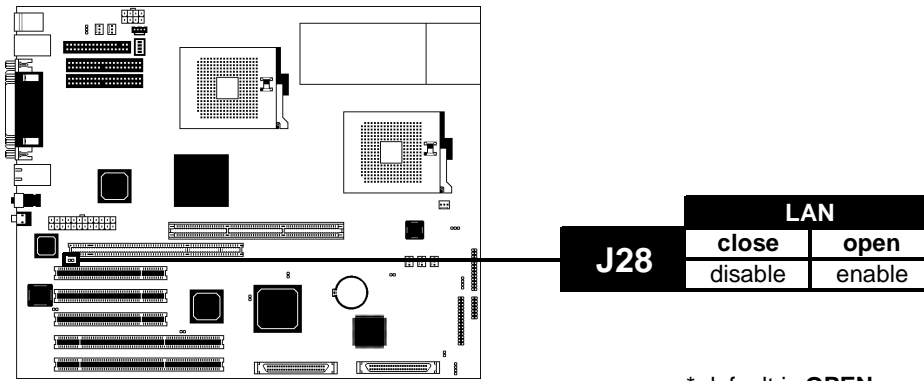

F. Onboard SCSI Enable/Disable (J51)

This jumper can disable the onboard SCSI ports. Please note that both SCSI ports will be disabled at the same time.

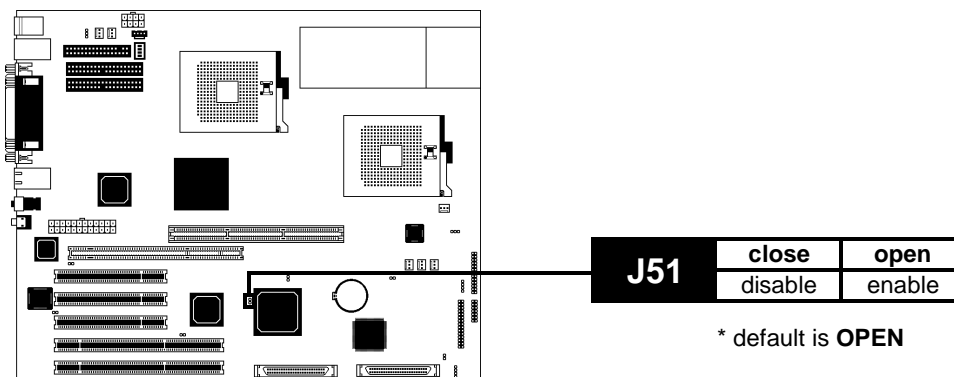

G. Speaker Connector (J23)

This is the 4-pin connector for a speaker.

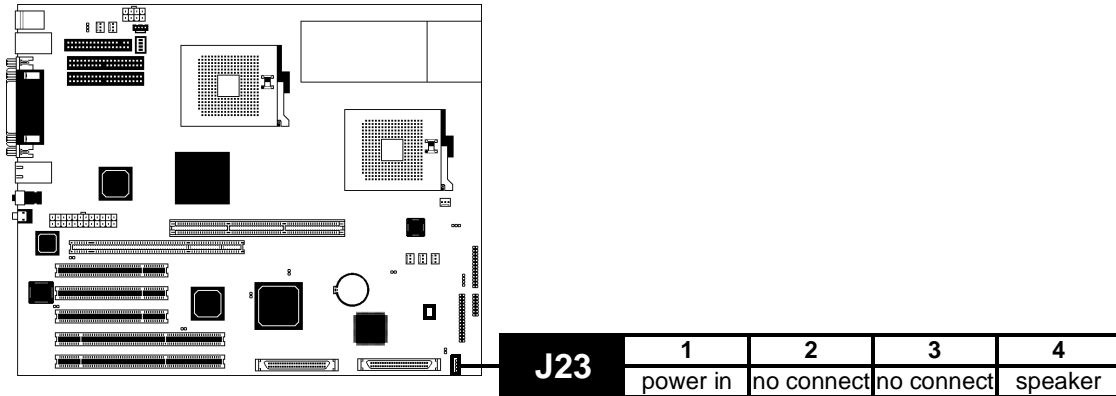

H. PCI Speed Select (J25)

This connector controls the speed of the 64-bit PCI slots.

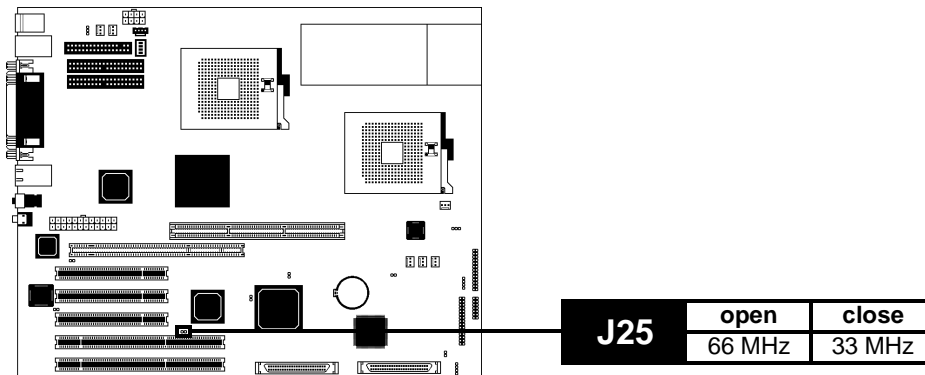

* default is **OPEN**

NOTE:

Tyan takes no responsibility and will not be held liable for damage related to the alteration of J25 from the correct setting corresponding to your PCI card manufacturer's designated operating speed.

I. FAN Connectors (FAN)

These are the 3-pin connectors for both CPU and chassis fans.

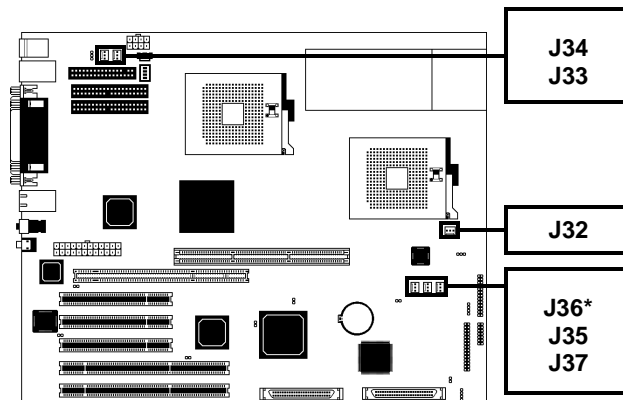

FAN	1	2	3
	ground	+12V	speed

Specifications	
Voltage	12V
Amperage	1.2A

NOTE:

NOTE: The FAN connectors are **12V** at **1.2A**. Tyan takes no responsibility and will not be held liable for damage related to the misuse of these jumpers.

J. Soft Power Connector

The soft power connector is part of jumper block **J24** (pins 6 and 8). This board uses the chipset for power management, including turning on and off the system. If the power button function option in the BIOS Power Management menu is set to "On/Off" (which is the default), pressing the power button once after the BIOS has booted up will turn the system on and off. If the power button function is set to Suspend, pressing the power button once will wake up the system or send it to Suspend mode. In this case, you cannot turn the system off unless you shut down through the Windows operating system or you hold the power button down for four seconds (BIOS-dependent feature).

K. Hardware Reset Switch Connector Installation

The reset switch on your chassis case provides you with the Hardware Reset function, which is the same as power on/off, except that the system will immediately execute a cold start after the reset button is pushed. The reset switch needs to be connected to jumper block **J24** (pins 5 and 7).

L. Flash Utility

You can upgrade the BIOS of this motherboard by using the Flash Utility (see **p.47**). Check the Tyan website for more details: <http://www.tyan.com>

* indicates an optional feature available on some Thunder i860 models

2.7 Mounting the Motherboard into the Chassis

Your chassis may include mounting hardware. If mounting hardware was included, you can use the following examples to help you in installing your motherboard into the chassis.

The chassis may have come with the studs integrated into the chassis wall, so in those cases you would only need to use screws (possibly included with your chassis) to install the motherboard. See the examples (**Figure 2.0**, shown below) for more details.

If the chassis includes mounting hardware without the studs pre-installed, then you will need to install the motherboard using the mounting hardware as shown in the examples **below**. Remember not to over-tighten any of the screws, or you might risk breaking internal traces in the surrounding area, or damage the motherboard in some other way.

Other examples of how to install your motherboard using other hardware (that may or may not have been included with your chassis) are shown below.



Type of hardware	One solution for installing motherboard	Another solution	Another solution
	 <p>screw motherboard base stud chassis wall</p>		
	 <p>motherboard base standoff chassis wall</p>		
	 <p>motherboard base standoff chassis wall</p>		

Figure 2.0

NOTE:

The diagrams above are only representative of a few solutions for installing a motherboard into the chassis. The installation procedure for installing your motherboard may differ.

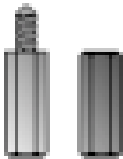
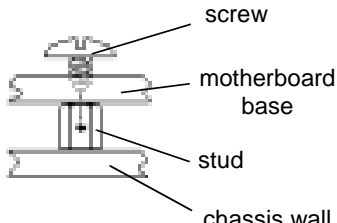
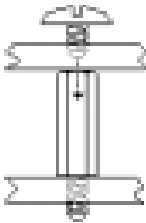
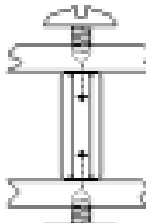
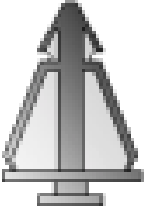
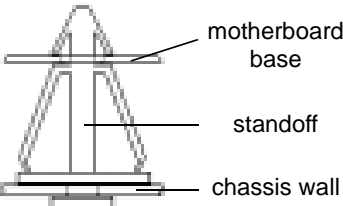
2.8 Installing Memory

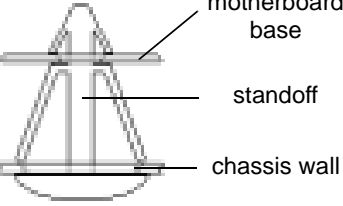
Please keep in mind that although some memory modules may appear to be high-quality, they may contain inferior or substandard parts. The type of memory you choose to install should be checked against the memory compatibility list, which is available from Tyan's website at <http://www.tyan.com>

Memory Installation Procedure

- Step 1** Line up your module so that the pins fit into the slot. There is only one way your memory module can fit properly. Make sure that the short row of pins is lined up with the short gap in the RDRAM socket. See **Figure 2.1** (on p.17) for graphic details on how the memory should be installed.
- Step 2** Insert the memory module by pushing it into the socket with **even force**. Do not insert one end and then the other: install the whole module at once or you might damage the memory module and/or the socket.
- Step 3** Lock the memory into place by pushing the clips back on either end of the socket onto the notches in the ends of the memory module, as shown **below**.

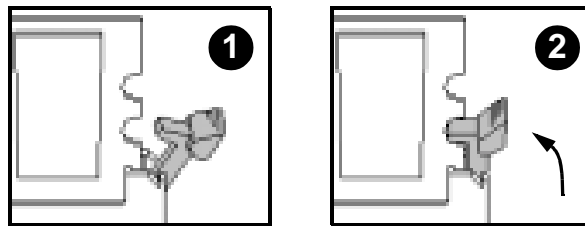

Memory Uninstallation Procedure

Removing the RIMM is just the reverse: simply pull back the clips from the memory module (as shown **below**), and carefully pull the module straight out. Place the memory modules in an anti-static bag as soon as you remove them to avoid static damage.

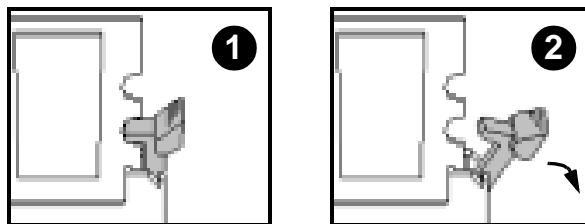

NOTE:

Also take care that you do not cause yourself injury if you are removing the memory modules after using the motherboard, since the module(s) may be hot.

Here are some details of memory installation for this board:

- ➡ Inner and outer RIMM sockets must be matching (e.g. if you have one RIMM module in the inner socket, another RIMM module must be installed in the other inner socket, and so on). See **p. 20** and **Figure 2.1** (below) for an example.

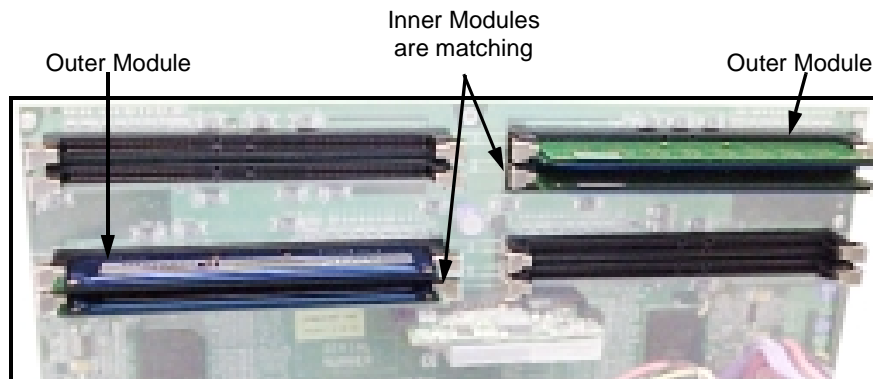

Figure 2.1

- ➡ Any empty slots must be filled with C-RIMM Continuity modules. Tyan has included (2) C-RIMM modules for your convenience (examples** are shown above in **Figure 2.1**).

- ➡ This motherboard supports up to 2GB* PC800 ECC Registered RDRAM. Check the Tyan memory compatibility section of the website for more details: <http://www.tyan.com>

* not verified at time of print, check the Tyan website for updates: <http://www.tyan.com>

** note: the examples may not necessarily represent the actual C-RIMMs included with the board.

Memory Configuration Examples

Figure 2.2 and the table below should be used in conjunction to determine possible memory configurations. Not all possible configurations are listed. (NOTE: C-RIMM means Continuity RIMM)

NOTE: The Rambus memory modules must be installed in a top-to-bottom fashion (e.g. fill in socket 1, then socket 2, and match the memory quantity in socket 3 with socket 1's memory quantity, and then match the memory quantity in socket 4 with socket 2's memory quantity, and so on).

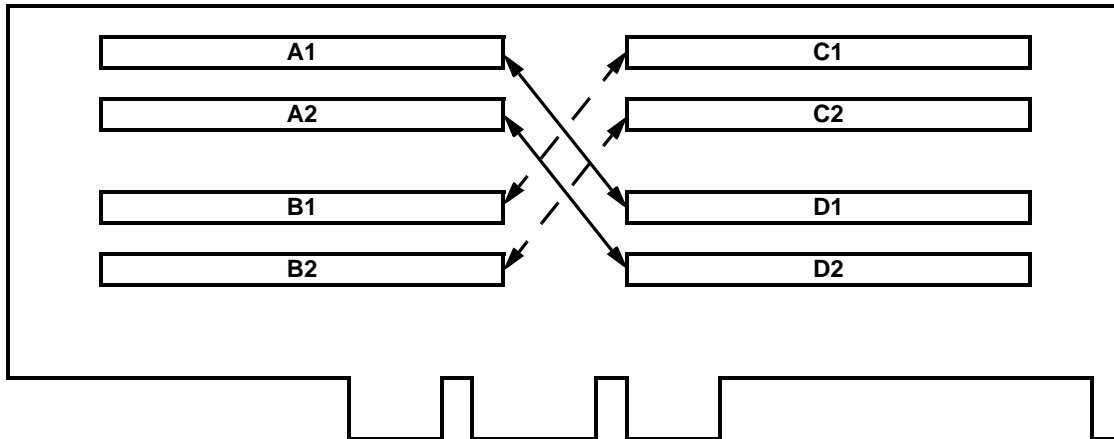

Figure 2.2 - Overhead view of memory banks*

Total of 4GB** PC800 Registered RDRAM possible								
A1	64MBx1	64MBx1	64MBx1	128MBx1	128MBx1	256MBx1	512MBx1	512MBx1
A2	C-RIMM	C-RIMM	64MBx1	C-RIMM	128MBx1	C-RIMM	C-RIMM	512MBx1
D1	64MBx1	64MBx1	64MBx1	128MBx1	128MBx1	256MBx1	512MBx1	512MBx1
D2	C-RIMM	C-RIMM	64MBx1	C-RIMM	128MBx1	C-RIMM	C-RIMM	512MBx1
C1	0	64MBx1	64MBx1	128MBx1	128MBx1	256MBx1	512MBx1	512MBx1
C2	0	C-RIMM	64MBx1	C-RIMM	128MBx1	C-RIMM	C-RIMM	512MBx1
B1	0	64MBx1	64MBx1	128MBx1	128MBx1	256MBx1	512MBx1	512MBx1
B2	0	C-RIMM	64MBx1	C-RIMM	128MBx1	C-RIMM	C-RIMM	512MBx1
TOTAL	128MB	256MB	512MB	512MB	1024MB	1024MB	2048MB**	4096MB**

* RIMM sockets are numbered in the diagram only, as an aid to proper memory installation

** not verified at time of print, check the Tyan website for updates: <http://www.tyan.com>

Due to the memory features of the Thunder i860, the board requires the use of a Memory Expansion Card (MEC), shown below.

Configuration of the memory may require Continuity RIMMs (C-RIMMs). If C-RIMMs are required, it will be shown in the example.

Please take care to note the **shadings** in the RIMM sockets, and the corresponding value in the **Installation Legend**.

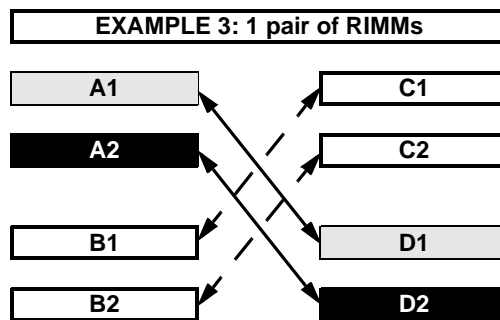
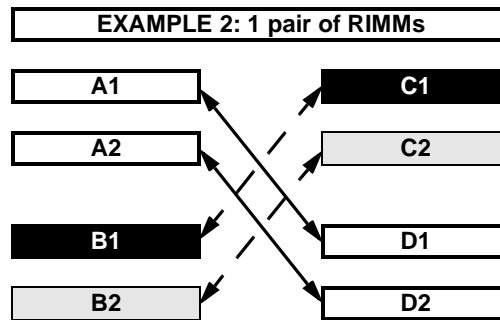
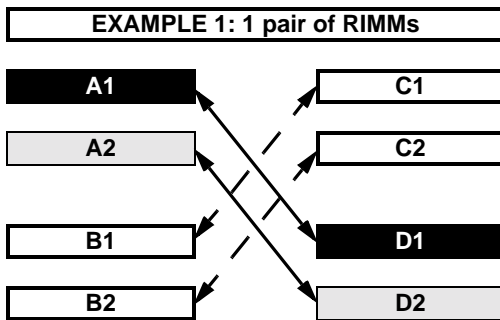
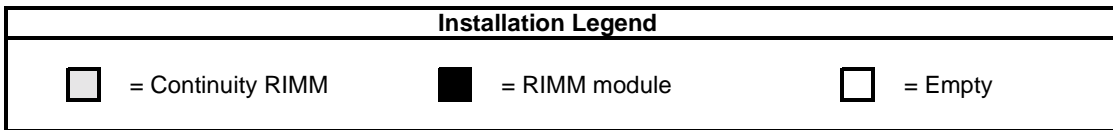
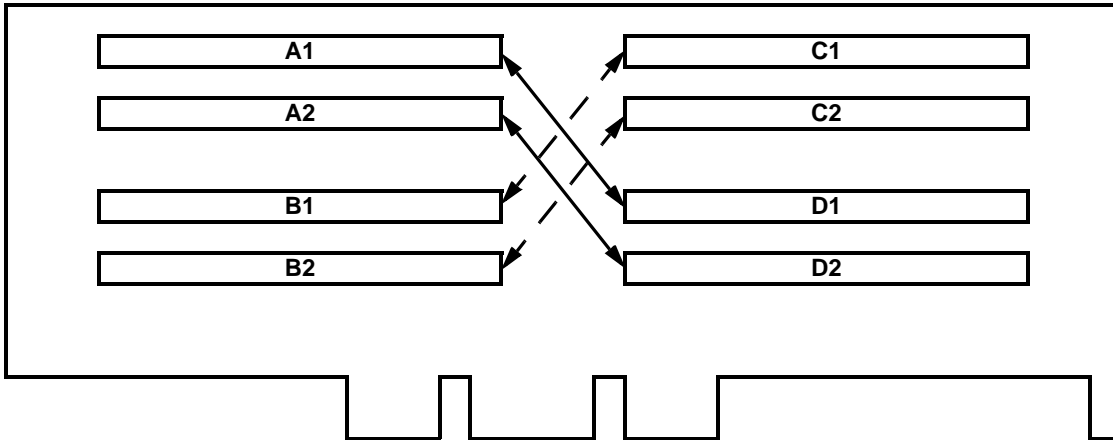

EXAMPLE 4: 1 pair of RIMMs

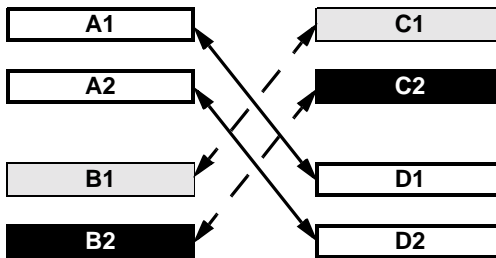

EXAMPLE 5: 2 pairs of RIMMs

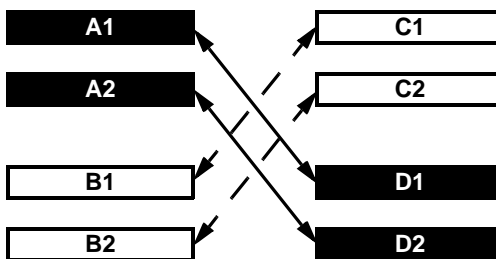

EXAMPLE 6: 2 pairs of RIMMs

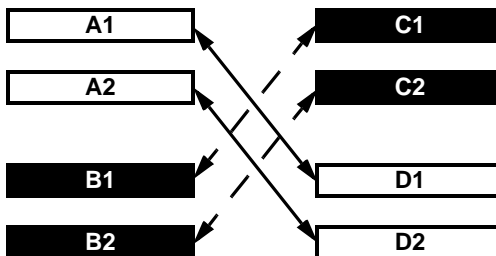

EXAMPLE 7: 4 pairs of RIMMs

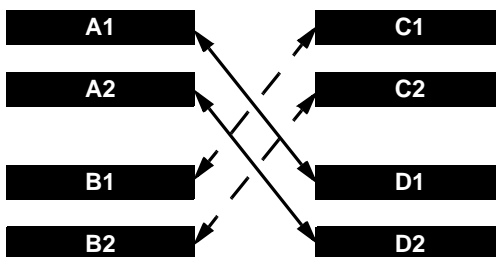

2.9 Installing the CPU and Cooling Fan

Intel Xeon processors **ONLY** (1.7* GHz and above*) can be used on the Thunder i860. For more information on CPU compatibility, check Tyan's website: <http://www.tyan.com>.

Remember the following: The CPU is a sensitive electronic component and it can easily be damaged by static electricity. Do not touch the CPU pins with your fingers. You should be able to insert the CPU into the socket with virtually no force. Do not press down hard on the CPU as you might bend or break the pins.

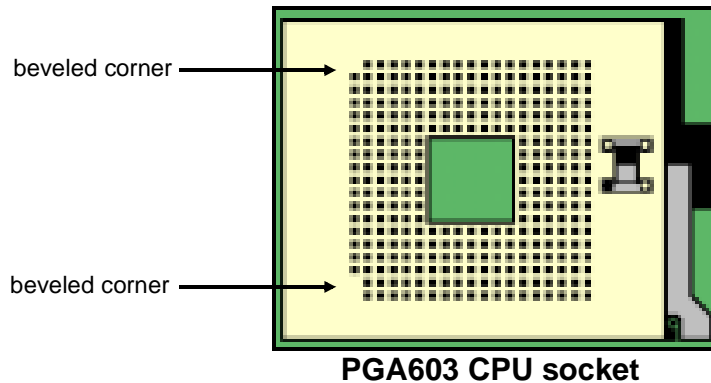

Installing the Intel Xeon CPU

Before installing the CPU, check it for damaged. Make sure that none of the pins are bent. There is only one way to install the CPU. There are two beveled corners in the socket face (shown in the image **above**) that match two beveled corners in the CPU pin set. Be very sure that the pins on the CPU match the socket face pins.

Step 1 Carefully lift the arm of the ZIF socket until it is at a 90-degree angle pointing away from the motherboard. be very careful not to damage any components that might be next to the CPU socket. Please note that each picture for this section (see **right**) corresponds to the step.

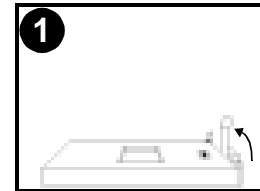

Step 2 There are two beveled corners on the CPU pin group, which will match the two angled corners on the socket face. Carefully install the CPU by lining both Pin 1 on the CPU and Pin 1 on the socket (see **right**), making sure the pins actually fit into the socket face. **Do not** force the CPU into the socket if it does not fit: check the pin alignment of CPU pins to socket holes.

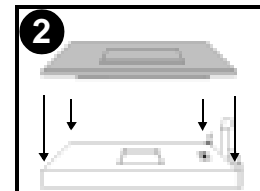

Step 3 Push down lightly on the CPU while lowering the arm of the socket to secure the CPU (see **right**). A squeaking noise may be heard while lowering the arm, or the socket may make a 'click' noise when the arm is locked into position: these noises are normal.

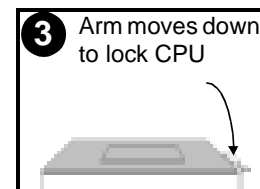

* not verified at time of print, check the Tyan website for updates: <http://www.tyan.com>

Installing the Cooling Fan(s)

After a CPU has been installed, you will need to **install the proper cooling device** for the CPU. This device, a heatsink/fan combination, can be purchased at many computer retail stores. Installation of the cooling device may vary depending on the fan manufacturer's design. You should also take space into consideration when install a cooling device: make sure the cooling device is not too big, or else you may end up damaging components around the CPU socket.

Tyan **highly recommends** that you use some type of thermal compound (available from many computer retail stores), between the CPU and heat sink, to maximize distribution of heat away from the CPU. Please use extra caution when installing any type of clamp-style fan, or else damage may occur to the CPU socket, and/or the CPU itself. See **the picture to the right** for an example of how to connect the cooling fan's power supply. Another diagram has also been provided below, to aid in CPU fan installation onto the socket. Check with your cooling device vendor for more details about installation.

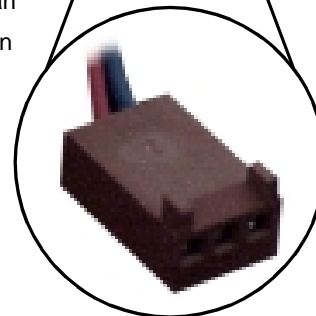
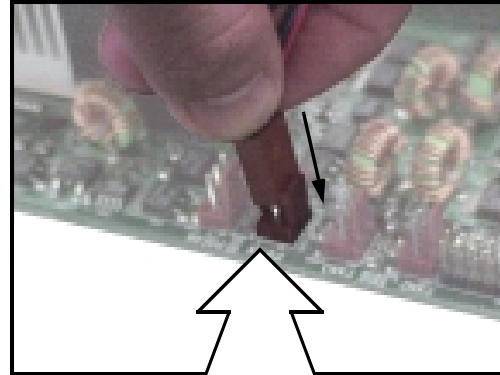

Close-up of fan connector

Please note that Xeon CPUs require a different cooling device than that of other socketed CPUs. Check with your vendor for details on cooling options.

FAN		
1	2	3
ground	+12V	speed

Voltage	12V
Amperage	1.2A

NOTE:

The FAN connector has a **12V, 1.2A limitation**. Tyan takes no responsibility and will not be held liable for damage related to the misuse of any FAN jumper.

Installing Chassis Fans

Alternatively, if you wish to also install chassis fans for increased cooling, headers are provided to power those fans as well (see **p. 15, section 2.6-H**). Chassis fan installation will vary depending on your chassis manufacturer's design. Please check with your chassis manufacturer for details on proper chassis fan installation.

2.10 Connecting IDE and Floppy Drives

A variety of IDE and ATAPI-compliant devices can be installed on this motherboard, such as hard disk drives (HDDs) and CD-ROMs.

Please keep in mind that on this motherboard, the primary IDE connector is **BLACK**, and the secondary IDE connector is **WHITE**. See **the picture to the right** for an example of the IDE cable properly connected to the motherboard, with the **BLUE** end of the IDE cable installed on the motherboard.

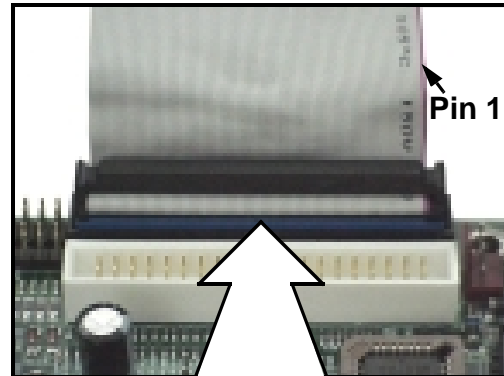

Pin 1 on the IDE cable is usually denoted by a red or colored stripe down one side of the cable. That side of the cable must match Pin 1 on the motherboard's IDE connector. There will also be a key pin on the cable that matches with a notch in the IDE connector, to ensure proper installation. Consult the documentation that came with your IDE/ATAPI device, or contact the device's manufacturer for more details on installation.

Please note that UltraDMA-100/66 IDE HDDs require a special 80-wire cable which has additional grounding wires. This cable has been included with this motherboard for your convenience. The UltraDMA-100/66 cable is backwards compatible with UltraDMA-33 and legacy IDE HDDs.

BLUE end goes to IDE connector

NOTE:	Only Tyan-approved cables are recommended for this motherboard. If you are using an existing configuration with older cables, your system might not function properly. Use only Tyan-approved cables (i.e. the ones included with your motherboard).
--------------	--

Some symptoms of incorrectly installed HDDs are...	
HDDs are not auto-detected	May be a Master/Slave configuration problem, bad IDE cable, or BIOS mis-configuration. Consult the HDD documentation or contact your HDD vendor.
Hard Disk Drive Fail message at bootup	May be a bad cable or lack of power going to the drive. Check the cables for damage and bad connections.
No video or beeps during bootup	Usually means the cable was installed backwards.
HDD lights are constantly on	Bad IDE cable or defective drives/motherboard. Try another HDD, or contact your HDD vendor.
HDD does not power on	Check power cables and cabling. May be a bad power supply or IDE drive problem.

Connecting Floppy Drives

See the picture below for an example of a floppy cable. Most of the current floppy drives on the market require that the cable be installed with the colored stripe positioned next to the power connector. In most cases, there will be a key pin on the cable which will force a proper connection of the cable.

The first floppy drive (sometimes denoted as A:) is usually attached to the end of the cable with the twist in it. Drive B: is usually connected to the second or third connector in the cable (the second or third connector after you install Drive A:). Refer to your floppy drive's installation instructions (if available), or contact your dealer if you are unsure about how to attach the floppy drive(s). Remember, you can only have 2 floppy drives connected at any given time.

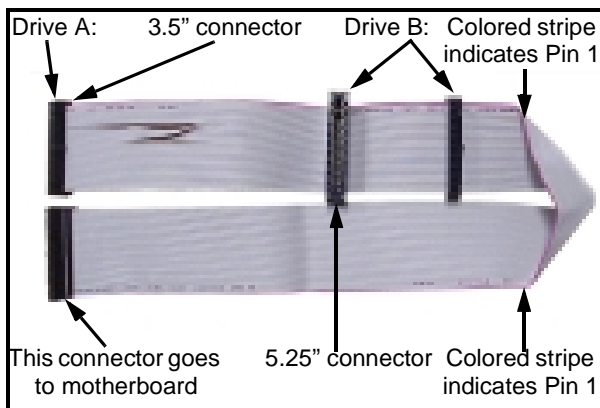
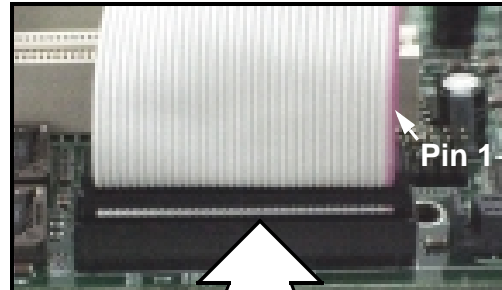
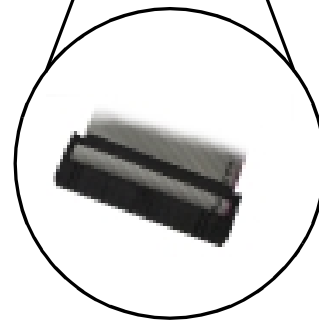

Figure 2.4*



Match striped side with Pin 1

Some symptoms of incorrectly installed FDDs are...	
FDDs are not auto-detected	Usually caused by faulty cables, cables put in backwards, or a bad floppy or motherboard. Try another floppy drive to verify the problem or try another cable. Also check to see if the onboard floppy is enabled in the BIOS.
Floppy Drive Fail message at bootup	The cable, floppy, or motherboard may be faulty. Try another cable or floppy drive to verify.
FDD does not power on	Check power cables and cabling. May be a bad power supply or IDE drive problem.
FDD light is constantly on	Usually signifies that the cable is on backwards. Reverse the cable at the floppy drive end and try again.

* Cable may vary. Diagram provided for reference only.

2.11 Installing Add-on Cards

There are a few rules you need to follow when installing add-on cards. In order to assure proper operation and a quick installation, adhere to the following guidelines:

- ➡ If you are going to install a PCI-bus interface card on your system, be aware that any one of the five PCI slots can support a Master or Slave device.
- ➡ NEVER force a card into a slot. If it doesn't fit, look at the socket on the motherboard to make sure there are no wires or other obstructions to the slot.
- ➡ NEVER plug an ISA card into a PCI slot. You will void your warranty and damage your system board if you do this.
- ➡ When plugging the card in, especially when installing long cards, try to push the entire card in at one time. Don't force one end of the card into the socket first and then the other, or a rocking motion between the card and the slot might occur, and could damage the pins within the socket.
- ➡ Make sure the cards are seated securely into their slots.
- ➡ Before turning on the system, make sure no cards are touching.
- ➡ Check the PCI device specifications with the PCI slot specifications (**p.5**) BEFORE installing!

When installing the add-on cards, make sure the cards are installed with **even** force; do not insert one end and then the other. See the before (**Figure 2.1a**) and after (**Figure 2.1b**) example installation images below for details.

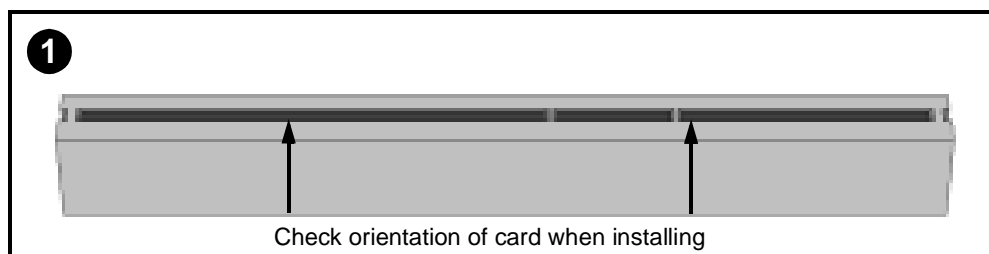

Figure 2.1a*

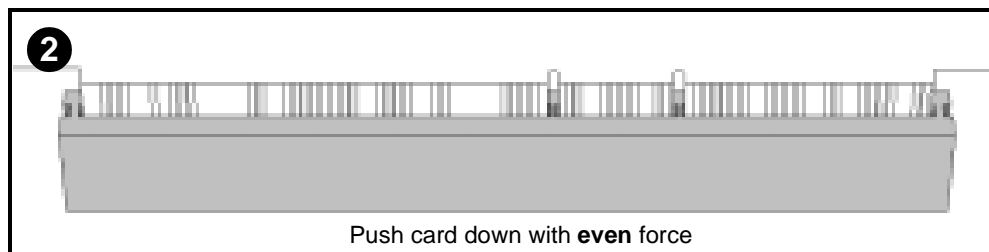

Figure 2.1b*

* diagrams are provided as an example for installation, and may not represent an actual slot

About the AGP Pro slot

If you are planning to install an AGP Pro, Pro 50, or 4X AGP Pro 50-compliant card, a small plastic retention piece must be removed from the AGP Pro slot before the card can be installed.

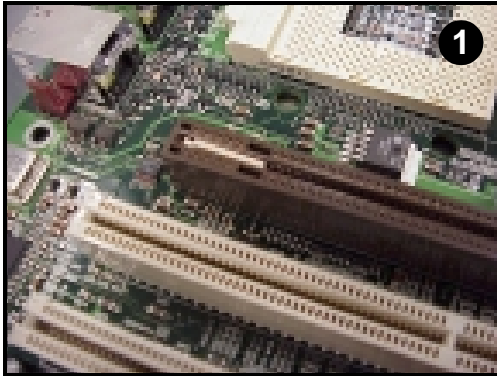

Figure 2.2a

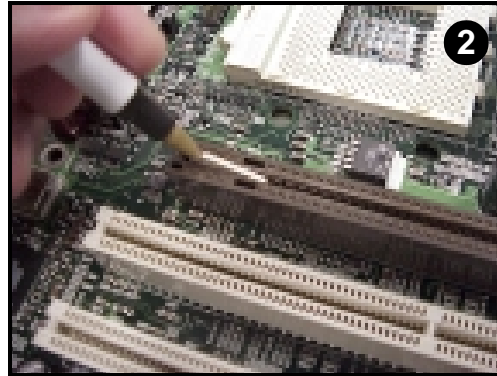

Figure 2.2b

First, make sure the card you're installing is an AGP Pro-compliant card. Next, locate the small plastic retention piece in the AGP Pro slot (**Figure 2.2a**, above), and use a tool with a small hard tip (such as a pen) to remove the retention piece (**Figure 2.2b**, above). **Tyan recommends you save this piece for future use (e.g. in case a regular AGP card is installed later on).**

To further ensure that the AGP card will not rock back and forth, make sure that the metal endpiece of the AGP card is flush with the motherboard edge.

NOTE:

Only remove the small plastic retention piece if you are going to install an AGP Pro-compliant card. Installing a regular AGP card without the retention piece can cause the card to rock back and forth, possibly damaging the card and/or motherboard.

Tyan takes no responsibility for and will not be held liable for damage related to use of regular AGP cards without the retention piece installed.

2.12 Connecting PS/2, USB, and Serial Devices

This motherboard includes ports for PS/2 mouse and keyboard, Universal Serial Bus (USB) devices, and serial and parallel devices. Please note that the upper PS/2 port is the mouse port, and the lower PS/2 port is for the keyboard (see **Figure 2.3** below).

Installation of peripheral/external devices may vary. For details on installation of devices into the various ports shown below, please consult your device's documentation, device manufacturer, or your dealer for details.

Connecting Serial and Parallel Ports

The serial and parallel ports can be used to connect various devices such as a mouse or printer. The connectors can only be connected one way: be sure and check the orientation of the connector before installing it into the port.

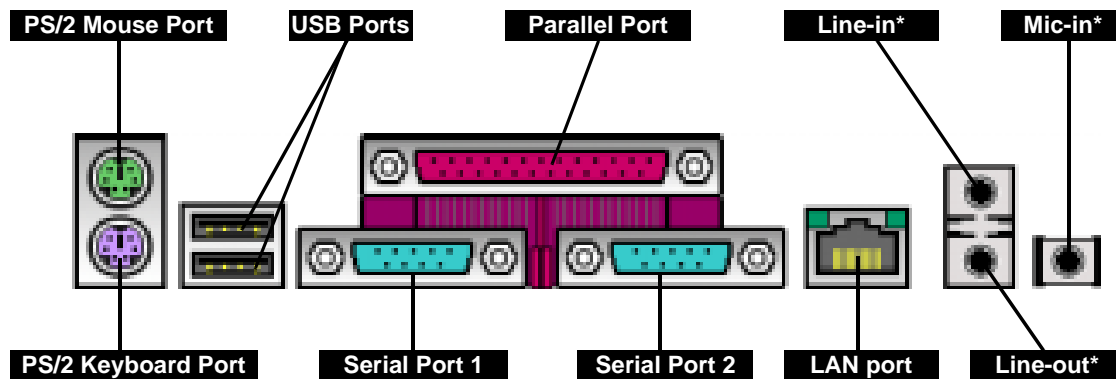

Figure 2.3

* indicates an optional feature available on some Thunder i860 models

2.13 Connecting the power supply

This motherboard requires a **dual Xeon-compatible power supply, such as the NMB IT002A430WSW.**

Step 1 The power supply for the Thunder i860 has **two power plugs, with clips.**

Both plugs must be installed in order to properly run the Thunder i860!

Failure to install both plugs may result in damage to the board!

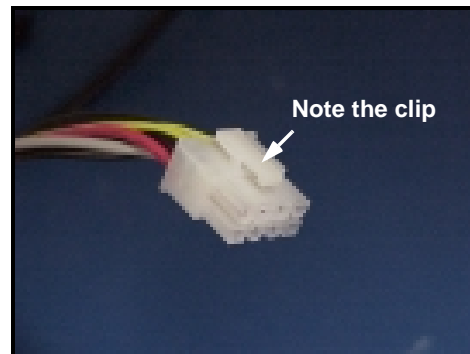

Figure 2.4a

Step 2 Shown on the right are two images of the **8-pin power plug.**

This plug should be installed **first** to ensure that the board will operate properly.

When you install the plugs, make sure the **clips** are installed over the **power socket tabs.**

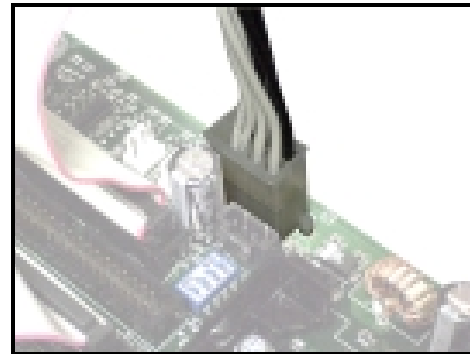

Figure 2.4c

Step 3 The other power plug has **24-pins.**
This plug **also needs to be installed.**

The 24-pin power plug is shown on the **right.**

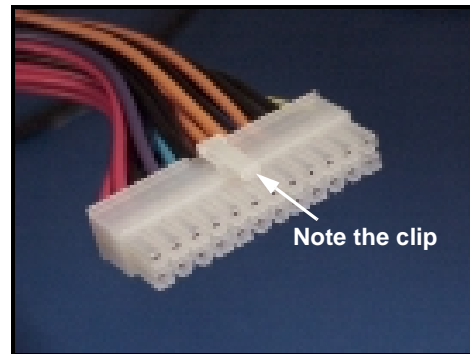

Figure 2.4b

Step 4 Take extra care that the clip matches the power socket tab on the 24-pin power connector as well.

Make sure all pins have been connected, or damage may occur to the board.

Tyan takes no responsibility and will not be held liable for damage due to incorrect power supply installation.

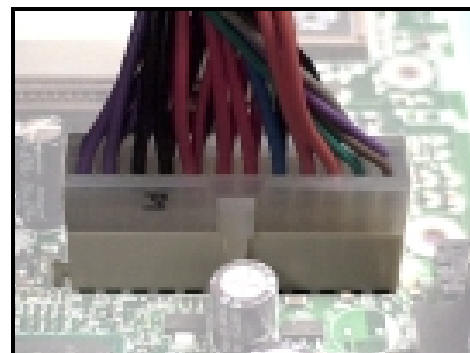

Figure 2.4d

You are done!

Other than checking the jumper settings and cable connections, and putting the case back together, you are done.

Installing a new motherboard may seem difficult, but by following these directions, you should have a fairly uneventful time installing our products. If you do encounter problems, your dealer will be able to help you, or you can consult one of our many technical support resources (see p. 7).

2.14 Frequently Asked Questions (FAQ)

Q: My system sometimes becomes unstable. How should I check the system?

A: The first thing to do is to check and see if you have any device conflicts related to the IRQ, or DMA. If you are using Microsoft Windows, the Control Panel is a good place to start investigating the conflict. Please consult your operating system documentation for details. Secondly, slowing down the memory timing in the BIOS' chipset setup section might help the situation as well. Many memory modules are not suitable for high performance systems and might be the main source of your problem. Also check to make sure you are using a **dualXeon-capable, APPROVED* or better power supply**. Lastly, make sure the motherboard is receiving adequate cooling.

Q: I have a question about memory compatibility; what memory will work on my motherboard?

A: Memory compatibility information can be found on Tyan's website at: <http://www.tyan.com>

Q: Where can I get additional accessories for my Tyan motherboard?*

A: You can purchase additional Tyan-approved accessories** at the Tyan Computer Online Store: <http://www.etyan.com>

Q: Where do I get pinout information for my motherboard?

A: Pinouts of certain headers are available on the Tyan website: <http://www.tyan.com>

Q: My motherboard is dead, how do I return it?

A: Contact the place of purchase or your distributor for assistance to return the motherboard for service. RMA issues will not be handled via e-mail by Tyan Tech Support. Please refer to the URL link here for more details: http://www.tyan.com/support/html/rma_faq.html

Q: How do I upgrade my BIOS?

A: Check the section about the Flash Utility (see **p. 47**) for information on upgrading your BIOS. BIOS update files, flash utilities, and instructions on how to install them are also available from the Tyan website at: <http://www.tyan.com>

Q: Why do I get a "CMOS checksum invalid" error message during POST?

A: If you get the above error message or "Invalid configuration, run Setup" message, it is an indication that the CMOS battery needs to be changed. Contact your dealer for assistance. Once you've replaced your battery or flashed your BIOS, don't forget to check the CMOS Reset section (see **p.12**) so that you can reset your CMOS.

* Check the Tyan website for updates: <http://www.tyan.com>

** Please check that your chassis is frontside USB capable if that is a feature you are planning to implement. Please check with your chassis vendor for details.

Chapter 3: BIOS Setup

Introduction to the BIOS setup

The BIOS is the basic input/output system, required by the computer to perform functions such as CPU and hard drive support. This chapter describes different settings for the BIOS that can be used to configure your system.

The BIOS section of the manual is subject to change without notice and is provided here for reference purposes only. The settings and configurations of the BIOS are current at the time of print, and therefore they may not be exactly the same as that displayed on your screen.

This manual describes the BIOS setup program. The setup program lets you modify basic configuration settings. The settings are then stored in a dedicated battery-backed memory, called NVRAM, that retains the information when the power is turned off.

The BIOS in your motherboard is a customized version of an industry-standard BIOS for IBM PC AT-compatible personal computers. It supports Intel x86 and compatible processors. The BIOS provides critical low-level support for the system central processing, memory, and I/O subsystems.

The BIOS has been customized by adding important, but non-standard, features such as virus and password protection, power management, and detailed fine-tuning of the chipset controlling the system. The rest of this manual is intended to guide you through the process of configuring your system using this BIOS setup program.

Starting Setup

The BIOS is immediately activated when you first turn on the computer. The BIOS reads system configuration information in CMOS RAM and begins the process of checking out the system and configuring it through the Power-On Self Test (POST).

When these preliminaries are finished, the BIOS seeks an operating system on one of the data storage devices (HDD, floppy drive, etc.) If one is found, the BIOS will launch that operating system and hand control of system operations to it. You can start the setup program by pressing the **[F2]** key while the system is booting up.

Setup Keys

The table below shows how to navigate in the setup program using the keyboard.

Key	Function
Tab	Moves from one selection to the next
Left/Right Arrow Keys	Change from one menu to the next
Up/Down Arrow Keys	Move between selections
Enter	Opens highlighted section
PgUp/PgDn Keys	Change setting

Getting Help

Press **[F1]** to display a small help window that describes the appropriate keys to use and the possible selections for the highlighted item. To exit the Help Window press **[ESC]** or the **[F1]** key again.

In Case of Problems

If you discover that you have trouble booting the computer after making and saving changes with the BIOS setup program, you can restart the computer by either:

-  Holding the power button down until the computer shuts off

The best advice is to alter only settings that you thoroughly understand. In particular, do not change settings in the Chipset screen unless you are absolutely sure that you need to. The Chipset defaults were carefully chosen by Tyan or your system manufacturer for the best performance and reliability. Even a seemingly small change to the Chipset setup may cause the system to become unstable.

Setup Variations

Not all systems have the same setup program. While the basic look and function of the setup program remains more or less the same for all systems, the appearance of your Setup screen may differ from the screens shown here. Each system design and chipset combination require custom configurations. In addition, the final appearance of the setup program depends on your system designer. Your system designer can decide that certain items should not be available for user configuration, and remove them from the BIOS setup program. **NOTE: Items marked with “(optional)” denote features that may not exist in your BIOS setup.**

3.1 Main Setup

In this screen, you can alter general features such as the date and time, as well as access the IDE configuration screens. Note that the options listed below are for options that can directly be changed within the **Main Setup** screen.

Enable ACPI (debug only)	FORMAT:	<i>y/n</i>
	OPTIONS:	Yes / No
	NOTES:	Debug purposes only
Operating System	FORMAT:	<i>[option]</i>
	OPTIONS:	Win98 WinME Win2K NT4/Linux/Other
	NOTES:	Choose 'Other' for other OS
Reset Configuration Data	FORMAT:	<i>[option]</i>
	OPTIONS:	Yes Erases all configuration data in a section of memory for ESCD (Extended System Configuration Data) which stores the configuration settings for non-PnP plug-in devices. No Does not erase ESCD.
	NOTES:	Select Yes when required to restore the manufacturer's defaults.
System Time	FORMAT:	<i>hh:mm:ss</i>
	OPTIONS:	hh = hours mm = minutes ss = seconds
	NOTES:	System time works on 24-hour format
System Date	FORMAT:	<i>mm/dd/yyyy</i>
	OPTIONS:	mm = month dd = day yyyy = year

3.2 Advanced Setup

Options such as I/O device interfaces can be altered through the subscreens listed in this setup screen.

Processors	Discussed below
Chipset	Discussed on p. 37
Floppy Disk Drive	Discussed on p. 37
IDE Devices	Discussed on p. 38
Integrated SCSI Controller	Discussed on p. 39
Integrated Network Interface	Discussed on p. 39
Integrated I/O Ports	Discussed on p. 40
Integrated Audio	Discussed on p. 42
AGP Slots (Graphics)	Discussed on p. 42
PCI Device, Slot #1 (.. 2, 3)	Discussed on p. 43
PCI Device, Slot #4 (64-bit)	Discussed on p. 43
PCI Device, Slot #5 (64-bit)	Discussed on p. 43

3.2-A. Processors screen (optional)

Options related to the processors can be altered through this screen.

Processor Speed	FORMAT:	[<i>speed</i>]
	OPTIONS:	800MHz, 900MHz, 1.00GHz, 1.10GHz, 1.20GHz, 1.30GHz, 1.40GHz, 1.50GHz, 1.60GHz, 1.70GHz, 1.80GHz, 1.90GHz, 2.00GHz, 2.10GHz, 2.20GHz, 2.30GHz
	NOTES:	Selects the speed of your CPU. DO NOT USE A HIGHER SETTING THAN YOUR CPU CAN HANDLE ACCORDING TO MANUFACTURER'S SPECIFICATIONS.

3.2-B. Chipset screen

Options related to the chipset functions can be altered through this screen.

Memory Hole	FORMAT:	[option]
	OPTIONS:	Extended Specifies if there is a section of memory that cannot be addressed by the ISA bus. If the memory hole exists, extended memory will handle it.
		No No memory hole.
NOTES:	Select Yes when required to restore the manufacturer's defaults.	

ECC Config	FORMAT:	[option]
	OPTIONS:	Disabled No error checking.
		ECC (multiple bits) Error checking & status report enabled. Data is corrected.
NOTES:	Select Yes when required to restore the manufacturer's defaults.	

ECC Error Type	FORMAT:	[option]
	OPTIONS:	None No error type specified
		SMI Structure of Management Information
		SCI System Control Interrupt
		NMI Non-Maskable Interrupt

SERR Signal Condition	FORMAT:	[option]
	OPTIONS:	None ERR signals not output under any condition.
		Single bit ERR signal output for a single bit
		Multiple bits ERR signal output for multiple bits
		Both ERR signal output for both instances.

3.2-C. Floppy Disk Drive screen

Options related to the Floppy Drive interface can be altered through this screen.

Floppy Disk Drive A:	FORMAT:	[size in MB] [media dimensions]
	OPTIONS:	360KB, 5 1/4" 1.2MB, 5 1/4" 720KB, 3 1/2" 1.44/1.25MB, 3 1/2" 2.88MB, 3 1/2" Not Installed Disabled
NOTES:	This option is provided for your floppy device needs. It is also linked to the Boot Sequence in the Boot Menu .	

3.2-D. IDE Devices screen

Options related to the PCI slots can be altered through this screen.

Primary Master/Slave	Discussed below
-----------------------------	------------------------

Secondary Master/Slave	Discussed below
-------------------------------	------------------------

Type	FORMAT:	[option]	
	OPTIONS:	None	Auto-typing is not able to supply the drive type, or the user has selected <i>None</i> to disable any drives that might be installed.
		1 to 39	Pre-configured drive parameters. This option is dependent on your drive.
		User	The user must define the different parameters of the drive.
		Auto	Auto-detect the drive parameters.
		IDE Removeable	Removeable read-and-write media (e.g. Zip drive).
		CD-ROM	Readable CD-ROM drive.
		ATAPI Removeable	Removeable ATAPI media (e.g. USB Zip drive).
NOTES:	All options are dependent on the drive.		

Multi-Sector Transfers	FORMAT:	[option]	
	OPTIONS:	Disabled	Disables the feature.
		Standard	Standard is 1 sector per block.
		2 sectors 4 sectors 8 sectors 16 sectors	Number of sectors transferred per block.
		NOTES:	All options are dependent on the drive.

LBA Mode Control	FORMAT:	[option]	
	OPTIONS:	Disabled / Enabled	Enabling LBA causes logical block addressing to be used in place of Cylinders, Heads, and Sectors.
	NOTES:	All options are dependent on the drive.	

32-bit I/O	FORMAT:	[option]	
	OPTIONS:	Disabled / Enabled	Enables 32-bit communication between CPU and IDE card. Requires PCI or local bus.
	NOTES:	All options are dependent on the drive.	

(continued on next page)

(continued from previous page)

Transfer Mode	FORMAT:	[option]
	OPTIONS:	Standard Selects the method for transferring data between the HDD and system memory. Fast PIO 1 Fast PIO 2 Fast PIO 3 Fast PIO 4 FPIO 3 / DMA 1 FPIO 4 / DMA 2
	NOTES:	The Setup menu only lists those options supported by the drive and platform.

UltraDMA Mode	FORMAT:	[option]
	OPTIONS:	Disabled Selects UltraDMA mode for the installed device. Mode 0 Mode 1 Mode 2 Mode 3 Mode 4 Mode 5
	NOTES:	The Setup menu only lists those options supported by the drive and platform.

Large Disk Access Mode	FORMAT:	[option]
	OPTIONS:	Other Select Other if you have another operating system such as UNIX.
	NOTES:	A large disk is one that has more than 1024 cylinders, more than 16 heads, or more than 63 tracks per sector.

Integrated IDE Controller	FORMAT:	[option]
	OPTIONS:	Both Channels Selects the IDE channels to be used. Disabled Primary Secondary

3.2-E. Integrated SCSI screen

Options related to the integrated SCSI controller can be altered through this screen.

Integrated SCSI	FORMAT:	[option]
	OPTIONS:	Enabled / Disabled
	NOTES:	Enables or disables the integrated SCSI
Option ROM Scan	FORMAT:	[option]
	OPTIONS:	Enabled / Disabled
	NOTES:	Enables or disables the SCSI option ROM (if present)
Enable Master	FORMAT:	[option]
	OPTIONS:	Enabled / Disabled
	NOTES:	Enables or disables bus mastering on the SCSI controller
Latency Timer	FORMAT:	[address]
	OPTIONS:	Default, 0020h, 0040h, 0060h, 0080h, 00A0h, 00B0h, 00C0h, 00E0h
	NOTES:	Sets the bus master clock rate. A device that has high priority and high throughput may benefit from a greater value.

3.2-F. Integrated Network screen

Options related to the integrated LAN controller can be altered through this screen.

Integrated Network	FORMAT:	[option]
	OPTIONS:	Enabled / Disabled
	NOTES:	Enables or disables the integrated LAN
Option ROM Scan	FORMAT:	[option]
	OPTIONS:	Enabled / Disabled
	NOTES:	Enables or disables the LAN option ROM (if present)
Enable Master	FORMAT:	[option]
	OPTIONS:	Enabled / Disabled
	NOTES:	Enables or disables bus mastering on the LAN controller
Latency Timer	FORMAT:	[address]
	OPTIONS:	Default, 0020h, 0040h, 0060h, 0080h, 00A0h, 00B0h, 00C0h, 00E0h
	NOTES:	Sets the bus master clock rate. A device that has high priority and high throughput may benefit from a greater value.

3.2-G. Integrated I/O Ports screen

Options related to the integrated I/O interface ports can be altered through this screen.

Serial Port A (.. B)	FORMAT:	[option]	
	OPTIONS:	Disabled	'Disabled' turns off the port.
		Enabled	'Enabled' requires you to enter the base I/O address and the INT number on the next line.
Auto	'Auto' makes the BIOS configure the port during POST.		

Base I/O	FORMAT:	[option]	
	OPTIONS:	3F8, 2F8 3E8, 2E8	These options are dependent on the IRQ, and vice versa.
		NOTES:	Recommended combinations include '3F8, IRQ4' and '2F8, IRQ3'.

Interrupt	FORMAT:	[option]	
	OPTIONS:	IRQ4 IRQ3	These IRQs are paired with the Base I/O option.
		NOTES:	Recommended combinations include '3F8, IRQ4' and '2F8, IRQ3'.

Parallel Port	FORMAT:	[option]	
	OPTIONS:	Disabled	'Disabled' turns off the port.
		Enabled	'Enabled' requires you to enter the base I/O address and the INT number.
Auto	'Auto' makes the BIOS configure the port during POST.		

Mode	FORMAT:	[option]	
	OPTIONS:	Output only	Standard one-way protocol for parallel devices.
		Bi-directional	Two-way protocol for parallel devices.
		EPP	Enhanced Parallel Port interface may provide higher bandwidth, if an EPP device is used.
ECP		Enhanced Capability Port interface may provide higher bandwidth, if an ECP device is used.	

(continued on next page)

(continued from previous page)

Base I/O	FORMAT:	[option]	
	OPTIONS:	378 278 3BC	These options appear when the parallel port is set to 'Enabled'.

Interrupt	FORMAT:	[option]	
	OPTIONS:	IRQ5 IRQ7	These options appear when the parallel port is set to 'Enabled'.

3.2-H. Integrated Audio screen (optional)

Options related to the integrated audio can be altered through this screen.

Integrated Audio	FORMAT:	[option]	
	OPTIONS:	Enabled / Disabled	
	NOTES:	Enables or disables the integrated audio	

Enable Master	FORMAT:	[option]	
	OPTIONS:	Enabled / Disabled	
	NOTES:	Enables or disables bus mastering for the audio controller	

Latency Timer	FORMAT:	[address]	
	OPTIONS:	Default, 0020h, 0040h, 0060h, 0080h, 00A0h, 00B0h, 00C0h, 00E0h	
	NOTES:	Sets the bus master clock rate. A device that has high priority and high throughput may benefit from a greater value.	

3.2-I. AGP Slot (Graphics) screen

Options related to the AGP slot can be altered through this screen.

Enable Master	FORMAT:	[option]	
	OPTIONS:	Enabled / Disabled	
	NOTES:	Enables or disables bus mastering for the AGP video controller	

Latency Timer	FORMAT:	[address]	
	OPTIONS:	Default, 0020h, 0040h, 0060h, 0080h, 00A0h, 00B0h, 00C0h, 00E0h	
	NOTES:	Sets the bus master clock rate. A device that has high priority and high throughput may benefit from a greater value.	

Graphics Aperture	FORMAT:	[option]	
	OPTIONS:	4MB 8MB 16MB 32MB 64MB 128MB 256MB	Sets the size of the memory area reserved for storage of graphics data structures used by the AGP.

3.2-J PCI Device, Slot #1 (.. 2, 3, 4, 5) screen

Options related to the PCI slots can be altered through these screens (each PCI slot allotted a single setup screen).

PCI Device, Slot 1 (..2, 3, 4, 5)	FORMAT:	[option]
	OPTIONS:	Option ROM Scan (Enable or Disable) Enables or disables device expansion ROM.
		Enable Master (Enable or Disable) Enables selected device as a PCI bus master. Not every device can function as a master. Check your device documentation.
	Latency Timer (0020h, 0040h, 0060h, 0080h, 00C0h, Default) Sets the bus master clock rate. A device that has high priority and high throughput may benefit from a greater value.	

3.3 Security Setup

Options such as password protection can be altered through this setup screen.

Set Administrator Password	FORMAT:	[press the [ENTER] key]
	OPTIONS:	[Enter] Enter up to 16 alphanumeric characters. You will be asked to confirm the password. In related systems, features will be accessible only by users who use the supervisor password.

Set User Password	FORMAT:	[press the [ENTER] key]
	OPTIONS:	[Enter] Enter up to 16 alphanumeric characters. You will be asked to confirm the password. This feature will not be enabled if there is no administrator password set.

Power-on Password	FORMAT:	[press the [ENTER] key]
	OPTIONS:	[Enter] Enter up to 16 alphanumeric characters. You will be asked to confirm the password. This feature will not be enabled if there is no administrator password set.

(continued on next page)

(continued from previous page)

Start from floppy	FORMAT:	[option]	
	OPTIONS:	Disabled Enabled	Enabling this feature allows booting from the floppy device.
Start from CD-ROM	FORMAT:	[option]	
	OPTIONS:	Disabled Enabled	Enabling this feature allows booting from the CD-ROM device.
Start from HDD	FORMAT:	[option]	
	OPTIONS:	Disabled Enabled	Enabling this feature allows booting from the HDD device.
Hardware Protection	Discussed below		
Write on floppy disks	FORMAT:	[option]	
	OPTIONS:	Locked Unlocked	Selecting 'Locked' will prevent write access to the floppy device.
Locked Setup Configuration	FORMAT:	[option]	
	OPTIONS:	Yes No	Selecting 'Yes' will prevent access to the BIOS setup.
Hard Disk Root Sector	FORMAT:	[option]	
	OPTIONS:	Locked Unlocked	Selecting 'Locked' will prevent access to the HDD root sector.

3.4 Power Setup

Options related to the onboard power functions can be altered through this setup screen.

Remote Power-on	FORMAT:	[option]	
	OPTIONS:	Disabled Enabled	If enabled, the system can be powered on from a remote location.
After Power Failure	FORMAT:	[option]	
	OPTIONS:	Stay off	System stays off after power is lost.
		Power on	System will automatically power on when a power input signal is detected by the BIOS.
Last state		System will automatically power on and retain the last state it was in, once a power input signal is detected by the BIOS.	

3.5 Boot Setup

Options related to the boot functions can be altered through this setup screen.

Quickboot Mode	FORMAT:	[option]	
	OPTIONS:	Disabled Enabled	If enabled, boot time will decrease but some tests will not be run in POST.
Disp Option ROM Messages	FORMAT:	[option]	
	OPTIONS:	Disabled Enabled	If enabled, messages from each option ROM will be shown.
Preferred Video	FORMAT:	[option]	
	OPTIONS:	PCI AGP	Selects preferred video bus to initialize at bootup time.
Summary Screen	FORMAT:	[option]	
	OPTIONS:	Disabled Enabled	If enabled, the boot summary screen will show during bootup.
Boot Device Priority	Discussed below		
(menu dependent on devices detected)	FORMAT:	[option]	
	OPTIONS:	(dependent on devices detected)	Each item detected as a removeable device, will be listed in this section. As the user presses the '+' key, the item will move up in priority. The item at the top will take first priority, the second item takes next highest priority, and so on.

3.6 Exit Setup

This screen shows options for exiting the BIOS setup.

Exit Saving Changes	FORMAT:	[<i>option</i>]
	OPTIONS:	Yes Saves changes to CMOS No and exits BIOS setup.

Exit Discarding Changes	FORMAT:	[<i>option</i>]
	OPTIONS:	Yes Discard any changes and No then exit BIOS setup.

Chapter 4: System Resources

Note: If you experience problems with setting up your system, always check the following things in the following order:

MEMORY, VIDEO, CPU

By checking these items, you will most likely find out what the problem might have been when setting up your system. For more information on troubleshooting, check the Tyan website at <http://www.tyan.com>

4.1 Beep Codes

Fatal errors, which halt the boot process, are communicated through a series of audible beeps. For example, if the Phoenix BIOS POST can initialize the video but an error occurs, an error message will be displayed. If it cannot display video, it will convey a series of beeps.

If you hear one long beep followed by two short beeps, then a video problem has probably occurred and the BIOS is having difficulty initializing the video display. Any other beep sequences that may or may not occur are probably due to memory problems.

4.2 Flash Utility

Every BIOS file is unique for the motherboard it was designed for. For Flash Utilities, BIOS downloads, and information on how to properly use the Flash Utility with your motherboard, you must check the Tyan website: <http://www.tyan.com>

NOTE:

Please be aware that by flashing your BIOS, you agree that in the event of a BIOS flash failure, you must contact your dealer for a replacement BIOS. There are no exceptions. Tyan does not have a policy of replacing BIOS chips directly with end users. In no event will Tyan be held responsible for damage done to the BIOS by the end user.

Appendix I: SCSI Installation* and LAN Information

Introduction

With the dual channel onboard Ultra160 LVD SCSI option*, you can connect up to 30 SCSI peripherals such as hard drives, CD-ROMs, and tape drives. Please note that this guide only provides basic instructions on connecting SCSI devices to your motherboard. For more detailed SCSI installation instructions, refer to your SCSI device documentation or to LSI Logic's website: <http://www.lsillogic.com>

Features* of the LSI Symbios SCSI BIOS

- Configuration for up to 256 adapters - any 4 can be chosen for INT13 (bootrom) support
- SPI-3 Parallel Protocol Request (PPR)
- Basic Domain Validation

Legacy support for non-Ultra160 SCSI devices

The LVD signaling used for Ultra160 devices operates differently than single-ended signaling used on Ultra, Fast, and Fast Wide SCSI devices. Ultra160 LVD SCSI devices are designed with multi-mode capability so that if a single-ended device is connected to the Ultra160 LVD SCSI bus, the Ultra160 devices automatically switch to single-ended mode. When an Ultra160 LVD SCSI device operates in single-ended mode it is subject to the cable distance limitations and signal noise problems of that interface. LSI recommends that single-ended Ultra and earlier devices be kept on a separate channel than the Ultra160 LVD SCSI devices. This will permit the Ultra160 devices to operate at full speed and cable distances.

Setting up internal SCSI peripherals

Its very important that SCSI peripherals be set up before installing them to the SCSI connector. The setup for SCSI peripherals usually involves setting SCSI IDs, checking for termination, mounting the peripherals inside the chassis, and then hooking up power to each peripheral. Since setup can vary from peripheral to peripheral, always refer to the peripherals documentation for specific instructions. Below are some guidelines for setting SCSI IDs and termination on your peripherals.

Checking SCSI IDs

Both the motherboard SCSI connectors and each peripheral you connect need to have a unique ID, ranging from 0 to 15. IDs do not have to be sequential, as long as each connector and each peripheral has a different number for each channel. Each SCSI channel on the motherboard is preset to SCSI ID and should not be changed. If you will be booting from a SCSI HDD, its best to set the disk's ID at 0 or 1. Most SCSI HDDs come from the factory preset to ID 0. The IDs for internal peripherals are usually set with jumpers; external peripherals are usually set with a switch on the back of the peripheral. Check your peripheral's documentation for more details.

Terminating SCSI devices

To ensure reliable communication on the SCSI bus, the peripheral on the end of each cable, or the end of the cable itself, must have a terminator installed (or enabled). The peripherals between the ends of each cable must have the terminator removed (or disabled). Check your peripheral's documentation for more details.

Connecting SCSI peripherals

A total of 30 SCSI peripherals can be connector to the onboard SCSI connectors (15 devices per channel/connector). Before connecting peripherals, be sure to also review **Setting up internal SCSI peripherals** above.

Connecting internal cables for Ultra160 LVD SCSI devices

When connecting internal Ultra160 LVD peripherals there are special SCSI cables necessary to sustain the higher speeds of LVD signaling. If your cables are not marked, you can identify most Ultra160 LVD SCSI cables as having twisted pairs of the flat ribbon cable in between the device connectors. These cables will usually have a terminator built into the end of the cable.

Step 1 Locate the 68-pin internal Ultra160 LVD SCSI cable (it should look similar to the one shown directly below).

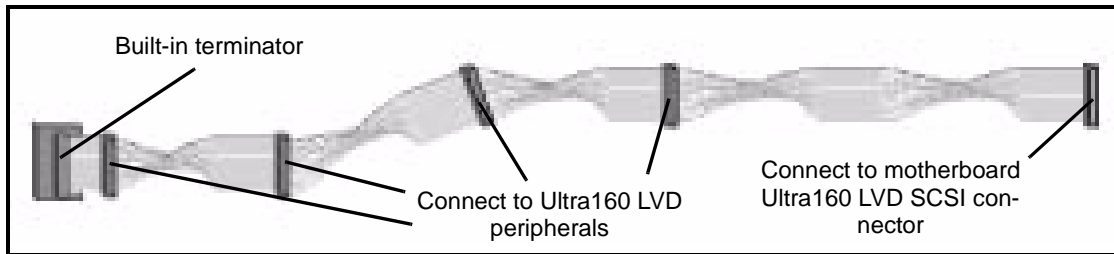

Step 2 Plug the long end of the cable(s) to the Ultra160 LVD SCSI connector(s) on the motherboard (either channel A or channel B). Note that the image(s) below may not be completely representative of your motherboard.

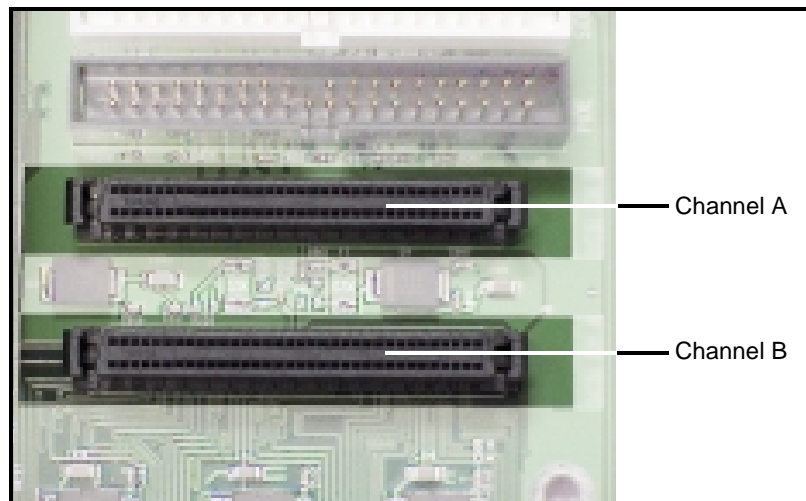

Step 3 Plug the remaining connectors to the internal Ultra160 LVD SCSI peripherals.

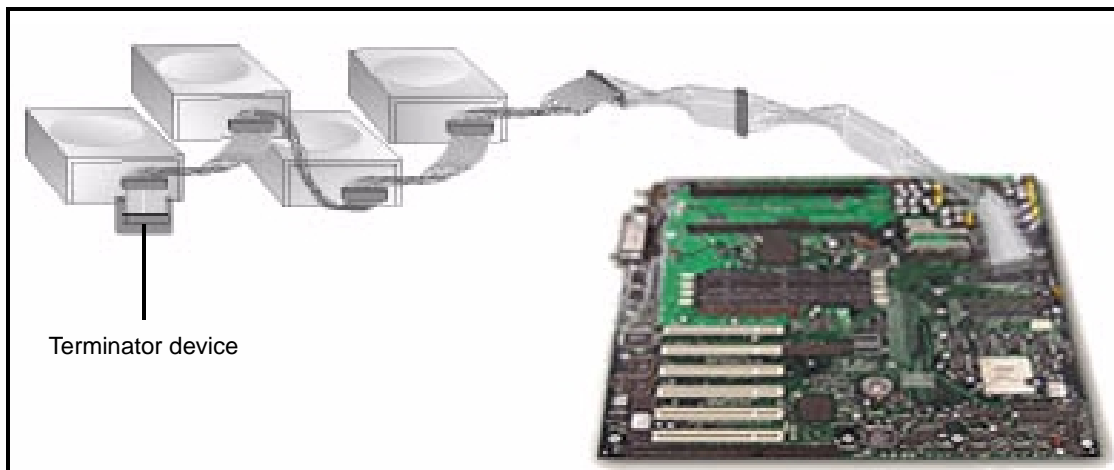

NOTE:

Internal Ultra160 SCSI peripherals come from the factory without termination. Proper termination is provided by the built-in terminator at the end of the Ultra160 internal SCSI cable.

Information on the LSI Symbios 53C1010 SCSI BIOS

The SCSI BIOS is the bootable ROM code that manages SCSI hardware resources. It is also specific to the family of Symbios SCSI controllers or processors. By integrating with the standard system BIOS, the Symbios SCSI BIOS extends the standard disk service routine through INT13h.

During boot time initialization, the SCSI BIOS will determine if there are other hard disks, such as an IDE drive, that are already installed by the system BIOS. If there are, the SCSI BIOS will map any detected SCSI drives **behind** the drive(s) already installed. Otherwise, the SCSI BIOS will install drives starting with the system boot drive. In this case, the system boots from a drive controlled by the SCSI BIOS. For 4.05 versions and higher, LSI Logic supports the BIOS Boot Specification (BBS).

Boot Initialization with BIOS Boot Specification (BBS)

The Symbios SCSI BIOS provides support for the BIOS Boot Specification (BBS), which allows you to choose which device to boot from by selecting the priority.

In the system BIOS setup, the Boot Connection Devices menu appears with a list of available boot options. Use that menu to select the device and rearrange the order. Then exit to continue the boot process.

CD-ROM Boot Initialization

The SCSI BIOS supports boot initialization from a CD-ROM drive.

The five types of emulation are:

- No emulation disk
- Floppy 1.2MB emulation disk
- Floppy 1.44MB emulation disk
- Floppy 2.88MB emulation disk
- Hard Disk Emulation

The type of emulation assigns the drive letter for the CD-ROM. For example, if a 1.44MB Floppy emulation CD was loaded, then the CD-ROM drive would become the designated A: drive, and the existing floppy (if any) would become drive B:.

Starting the SCSI BIOS Configuration Utility

This motherboard comes with the SCSI BIOS version 4.xx, and it includes the Symbios SCSI BIOS Configuration Utility so that you can change the default configuration of your SCSI host adapters. You may need to change the default configuration due to conflicts between device settings or if you are looking to optimize system performance.

If you have the LSI SCSI BIOS enabled (see **p. 33**), the following message will appear on your screen after the system BIOS boots:

Press CTRL-C to start Symbios Configuration Utility...

This message remains on your screen for about 5 seconds, giving you a short amount of time to start the utility. When you press **[CTRL-C]** to start the utility, the system will pause while it loads the utility, then the main menu for the utility will appear.

Error Messages

The following error messages may appear if something goes wrong during the boot process.

Error Message	Possible Reason For Error
Adapter removed from boot order, parameters will be updated accordingly	This appears when an adapter is removed from the system or relocated behind a PCI bridge.
Configuration data invalid, saving default configuration!	This appears if none of the information in the NVRAM is valid.
Found SCSI Controller not in following Boot Order List, to Add: Press Ctrl-C to start Symbios Configuration Utility...	This appears when less than four adapters are in the boot order and more adapters exist than are shown.

NOTE:	The SCSI BIOS Configuration Utility is a powerful tool. If you somehow disable all of your controllers, pressing CTRL-A (or CTRL-E on BIOS version 4.04 or later) after memory initialization during reboot allows you to re-enable and reconfigure.*
--------------	---

NOTE:	Not all devices detected by the Configuration Utility can be controlled by the BIOS. Devices such as tape drives and scanners require that a device driver specific to that peripheral be loaded. The SCSI BIOS Configuration Utility does allow parameters to be modified for these devices.
--------------	---

Using the Configuration Utility

Throughout the setup, selections that are not selectable are greyed out. Listed below are keys that you can use throughout the setup.

Key	Function
F1	Accesses the context sensitive help for the cursor-resident field.
F2	Sets cursor content to the menu selection area. Select a menu item and press [ENTER].
Arrow Keys	Select item
Home/End	Select item; use Up/Down/Left/Right keys to position the cursor.
+/-	Changes item value to next relative value.
Enter	Press [ENTER] to execute the field's associated function.
ESC	Abort/exit the current operating and/or exits the current screen. User confirmation may occur.

* under qualification at time of print, check Tyan website for updates: <http://www.tyan.com>

Main Menu

This is the Main Menu setup that displays the Host Bus Adapters and their corresponding settings. Below are the fields available along with their descriptions.

Field	Details on field
Adapter	Indicates the specific Symbios Host Adapter
PCI Bus	The PCI Bus number (range 0x00 - 0xFF, 0 - 255 decimal) assigned by the system BIOS to an adapter
Dev/Func	<p>Indicates the PCI Device/Function assigned by the system BIOS to an adapter.</p> <p>An 8-bit value mapped as follows:</p> <pre> Bit # 7 6 5 4 3 2 1 0 </pre> <p>Bits 2-0: Function (range 0 - 7)</p> <p>Bits 7-3: Device (range 0x00 - 0x1F, 0-31 decimal)</p>
Port Number	Indicates the I/O Port Number that communicates with an adapter. The system BIOS also assigns this number.
IRQ	Indicates the Interrupt Request Line used by an adapter. The system BIOS also assigns this value.
NVM	Indicates whether an adapter has non-volatile memory (NVM) associated with it. An adapter's configuration is stored in its associated NVM. NVM can refer to NVRAM that is resident on a host adapter or to system NVS.
Boot Order	Indicates the relative boot order (0 to 3) of an adapter. The Symbios SCSI BIOS traverses up to four adapters in the specified order in search of bootable media. Access the "Boot Adpater List" Menu to modify this item.

The next page describes the **Boot Adapter List** menu, available from the **Main Menu**.

Boot Adapter List

The adapter boot order specifies the order in which adapters will boot when more than one Symbios adapter is in a system.

Up to four of the total adapters in a system may be selected as bootable.

To add an adapter to the boot list, press [INSERT] while on the Boot Adapter List. This puts the cursor on the adapter select list. Use the arrow keys to select the desired adapter and press [ENTER] to add it to the end of the Boot Adapter List. Below are the fields available along with their descriptions.

Field	Details on field
Adapter	Indicates the specific Symbios Host Adapter
PCI Bus	The PCI Bus number (range 0x00 - 0xFF, 0 - 255 decimal) assigned by the system BIOS to an adapter
Dev/Func	Indicates the PCI Device/Function assigned by the system BIOS to an adapter. An 8-bit value mapped as follows: Bit # 7 6 5 4 3 2 1 0 Bits 2-0: Function (range 0 - 7) Bits 7-3: Device (range 0x00 - 0x1F, 0-31 decimal)
Boot Order	Specifies the relative boot order (0 to 3) of an adapter. - : decreases an adapter's relative boot order + : increases an adapter's relative boot order
Current Status	Indicates whether an adapter in the boot list was enabled during the most recent boot. Disabled adapters and their attached devices are ignored by the Symbios PCI SCSI BIOS., they are still visible to the Configuration utility.
Next Boot	Specifies whether to enable an adapter upon the next boot. The Symbios SCSI BIOS ignores disabled adapters and their attached devices although they are still visible to the Configuration Utility.

The next page describes the Global Properties menu, available from the Main Menu.

Global Properties

The Global Properties option on the Main Menu allows you to set Display and Video modes as well as a pause if an alert message has been displayed. Below are the fields available along with their descriptions.

Field	Details on field
Pause When Boot Alert Displayed	<p>This option specifies whether to pause for user acknowledgement after displaying an alert message during boot. The Boot Alert setting can be either No or Yes.</p> <p>To continue after displaying a message, specify No.</p> <p>To wait for any key after displaying a message, specify Yes.</p>
Boot Information Display Mode	<p>This option specifies the information display mode of the BIOS during boot. It controls how much information about adapters and devices are displayed during boot. The Display Mode setting can be either Terse or Verbose.</p>
Negotiate with devices	<p>This option sets the default value for synchronous and wide negotiations with specified devices. Options are: All, None, or Supported.</p>
Video Mode	<p>This option specifies the default video mode for the Configuration Utility. The Video Mode setting can be either Color or Monochrome. The monochrome setting enhances readability on a monochrome monitor.</p>
<Restore Defaults>	<p>Select this option to restore all default settings.</p>

The next page describes the Adapter Properties menu, available from the Main Menu.

Adapter Properties

The Adapter Properties menu allows you to view and modify adapter settings, and provides access to an adapter's device settings. Below are the fields available along with their descriptions.

Field	Details on field
<Device Properties>	To view and modify device properties, press [ENTER].
SCSI Parity	This field indicates whether SCSI parity is enabled for an adapter. When disabled, it is also necessary to disable disconnects for all devices, as parity checking for the reselection phase is NOT disabled. If a non-parity generating device disconnects, its operation will never complete because the reselection fails due to parity error.
Host SCSI ID	This field indicates the SCSI identifier of an adapter [0-7] or [0-15]. It is recommended that this field be set to the highest priority SCSI identifier, which is 7.
SCSI Bus Scan Order	This field indicates the order in which to scan SCSI identifiers on an adapter. Changing this item will affect drive letter assignment(s) if more than one device is attached to an adapter. Note: Changing this item may conflict with an operating system that automatically assigns drive order.
Removeable Media Support	This field specifies the removable media support option for an adapter. Three settings are allowed: None indicates no removable media support whether the drive is selected as first (BBS), or is first in the scan order (non-BBS). Boot Drive Only provides removable media support for a removable harddrive if it is first in the scan order. With Media Installed provides removable media regardless of the drive ordering.
CHS Mapping	This field defines how the Cylinder Head Sector values are mapped onto a disk without pre-existing partition information. CHS Mapping allows two settings: SCSI Plug-and-Play Mapping (default value), and Alternate CHS Mapping. SCSI Plug-and-Play Mapping automatically determines the most efficient and compatible mapping. Alternate CHS Mapping utilizes an alternate, possibly less efficient mapping that may be required if a device is moved between adapters from different vendors. <i>Note: Neither of these options has any effect after a disk has been partitioned using FDISK*. To change the CHS Mapping on a partitioned disk, use FDISK* to delete all partitions. Then reboot the system to clear memory or the old partitioning data will be reused, thus nullifying the previous operation.</i>

* CAUTION: Use care to ensure that the correct disk is the target of the FDISK.

Adapter Properties (continued)

Field	Details on field
<p align="center">Spinup Delay (secs)</p>	<p>This field indicates the number of seconds to wait between spinups of devices attached to an adapter. Staggered spinups will balance the total electrical current load on the system during boot. The default value is 2 seconds with choices between 1 and 10 seconds.</p>
<p align="center">Secondary Cluster Server</p>	<p>This field indicates whether an adapter has one or more devices attached that are shared with one or more other adapters and therefore, the Symbios PCI SCSI BIOS should avoid SCSI Bus resets as much as possible.</p> <p>This option allows the user to enable an adapter to join a cluster of adapters without doing any SCSI bus resets. This is a requirement for Microsoft Cluster Server. The default value is No with an alternate option of Yes.</p>
<p align="center">Termination Control</p>	<p>This field indicates whether an adapter has automatic termination control, and if so, its current status. Two settings are:</p> <p>Auto: The adapter automatically determines whether it should enable or disable its termination.</p> <p>Off: Termination at the adapter is off, the devices at the ends of the SCSI bus must terminate the bus.</p> <p>Note: If Auto is greyed out, it means the termination is automatic, not programmable.</p>
<p align="center"><Restore Defaults></p>	<p>Select this option to restore all default settings.</p>

The next page describes the Device Properties.

Device Properties

The Device Properties screen provides viewing and updating individual device settings for an adapter. Changing a setting for the host device (for example, SCSI ID 7) changes the setting for all devices. Below are the fields available along with their descriptions.

Field	Details on field																								
SCSI ID	This field indicates the device's SCSI identifier.																								
Device Identifier	This field indicates the ASCII device identifier string extracted from the device's Inquiry Data.																								
Sync Rate	<p>This field indicates the maximum synchronous data transfer rate, in Mega Transfer per second.</p> <table border="1"> <thead> <tr> <th>Mega Transfers/sec</th> <th>Data Width= 8 MB/s</th> <th>Data Width= 16 MB/s</th> <th>Synchronous Period (nsec)</th> </tr> </thead> <tbody> <tr> <td>0=Async</td> <td>0=Async</td> <td>0=Async</td> <td>0=Async</td> </tr> <tr> <td>5</td> <td>5</td> <td>10</td> <td>200</td> </tr> <tr> <td>10</td> <td>10</td> <td>20</td> <td>100</td> </tr> <tr> <td>20</td> <td>20</td> <td>40</td> <td>50</td> </tr> <tr> <td>40</td> <td>40</td> <td>80</td> <td>25</td> </tr> </tbody> </table>	Mega Transfers/sec	Data Width= 8 MB/s	Data Width= 16 MB/s	Synchronous Period (nsec)	0=Async	0=Async	0=Async	0=Async	5	5	10	200	10	10	20	100	20	20	40	50	40	40	80	25
Mega Transfers/sec	Data Width= 8 MB/s	Data Width= 16 MB/s	Synchronous Period (nsec)																						
0=Async	0=Async	0=Async	0=Async																						
5	5	10	200																						
10	10	20	100																						
20	20	40	50																						
40	40	80	25																						
Data Width	This field indicates the maximum data width in bits.																								
Scan ID	<p>This field indicates whether to scan for this SCSI identifier at boot time. This item can be used to ignore a device and to decrease boot time by disabling the inquiry of unused SCSI identifiers.</p> <p>Set this option to "No" if there is a device that you do not want to be available to the system. Also, on a bus with only a few devices attached, the user can speed up boot time by changing this setting to "No" for all unused SCSI IDs.</p>																								
Scan LUNs > 0	<p>This field indicates whether to scan for Logical Unit Numbers (LUNs) greater than 0 for a device. LUN 0 is always queried. This option should be used if a multi-LUN device responds to unoccupied LUNs or if it is desired to reduce the visibility of a multi-LUN device to LUN zero only.</p> <p>Set this option to "No" if you have problems with a device that responds to all LUNs whether they are occupied or not. Also, if a SCSI device with multiple LUNs exists on your system but you do not want all of those LUNs to be available to the system, then set this option to "No". This will limit the scan to LUN 0 only.</p>																								
Disconnect	This field indicates whether to allow a device to disconnect during SCSI operations. Some (mostly newer) devices run faster with disconnect enabled, while some (mostly older) devices run faster with disconnect disabled.																								

(continued on next page)

Device Properties (continued)

Field	Details on field
SCSI Timeout	<p>This field indicates the maximum amount of time [0 to 9999] in seconds to wait for a SCSI operation to complete.</p> <p>Since timeouts provide a safeguard that allows the system to recover should an operation fail, it is recommended that a value greater than 0 be used. A value of 0 allows unlimited time for an operation to complete and could result in the system hanging (waiting forever) should an operation fail.</p> <p>Press [ENTER], type in a value, and then press [ENTER] again to specify a new timeout value.</p>
Queue Tags	<p>This field indicates whether to allow the use of queue tags for a device. Currently the BIOS does not use queue tags. This item specifies queue tag control to higher level device drivers.</p>
Boot Choice	<p>This field indicates whether this device may possibly be selected as the boot device. This option is only applicable to devices attached to adapter number 0 (in the boot list) on non-BBS systems. It provides primitive BBS flexibility to non-BBS systems.</p>
Format	<p>Select this option to low-level format the device.</p> <p>If enabled, this option allows low-level formatting on a disk drive. Low-level formatting will completely and irreversibly erase all data on the drive.</p> <p>Note: Formatting will default the drive to a 512-byte sector size even if the drive had previously been formatted to another sector size.</p>
Verify	<p>Select this option to verify all sectors on the device and to reassign defective Logical Block Addresses (LBAs).</p>
<Restore Defaults>	<p>Select this option to restore all default settings.</p>

Quitting the SCSI BIOS Configuration Utility

Since some changes go into effect only after the system reboots, it is very important that you exit this utility properly. To exit, press [ESC] (escape key) and respond to the prompts that follow.

NOTE:

If you reboot the system without properly exiting from this utility, some changes may not take effect.

LAN Information

Your motherboard has an onboard Intel 82559 LAN controller, with 10/100 MBits/s transfer speed. For more information regarding the onboard LAN controllers, check the Intel website: <http://www.intel.com>

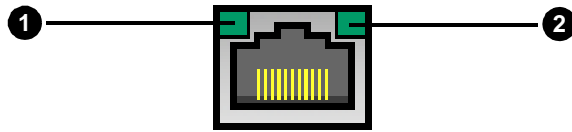

Below are some explanations of what the LEDs mean, and how they display the LAN's status.

LAN Status	LED (1) - Orange Light	LED (2) - Green Light
Good connection @ 10 Mbps	OFF	ON
Good connection @ 100 Mbps	ON	ON
No connection	OFF	OFF
Data being transferred	ON (10Mbps) Orange (100Mbps)	LED is blinking

Appendix II: Glossary

ACPI (Advanced Configuration and Power Interface): a power management specification that allows the operating system to control the amount of power distributed to the computer's devices. Devices not in use can be turned off, reducing unnecessary power expenditure.

AGP (Accelerated Graphics Port): a PCI-based interface which was designed specifically for demands of 3D graphics applications. The 32-bit AGP channel directly links the graphics controller to the main memory. While the channel runs at only 66 MHz, it supports data transmission during both the rising and falling ends of the clock cycle, yielding an effective speed of 133 MHz.

ATAPI (AT Attachment Packet Interface): also known as IDE or ATA; a drive implementation that includes the disk controller on the device itself. It allows CD-ROMs and tape drives to be configured as master or slave devices, just like HDDs.

ATX: the form factor designed to replace the AT form factor. It improves on the AT design by rotating the board 90 degrees, so that the IDE connectors are closer to the drive bays, and the CPU is closer to the power supply and cooling fan. The keyboard, mouse, USB, serial, and parallel ports are built-in.

Bandwidth: refers to carrying capacity. The greater the bandwidth, the more data the bus, phone line, or other electrical path, can carry. Greater bandwidth, then, also results in greater speed.

BBS (BIOS Boot Specification): is a feature within the BIOS that creates, prioritizes, and maintains a list of all Initial Program Load (IPL) devices, and then stores that list in NV memory. IPL devices have the ability to load and execute an OS, as well as provide the ability to return to the BIOS if the OS load process fails for some reason. At that point the next IPL device is called upon to attempt loading of the OS.

BIOS (Basic Input/Output System): the program that resides in the ROM chip, and provides the basic instructions for controlling your computer's hardware. Both the operating system and application software use BIOS routines to ensure compatibility.

Buffer: a portion of RAM which is used to temporarily store data, usually from an application, though it is also used when printing, and in most keyboard drivers. The CPU can manipulate data in a buffer before copying it, all at once, to a disk drive. While this improves system performance --- reading to or writing from a disk drive a single time is much faster than doing so repeatedly --- there is also the possibility of losing your data should the system crash. Information stored in a buffer is temporarily stored, not permanently saved.

Bus: a data pathway. The term is used especially to refer to the connection between the processor and system memory, and between the processor and PCI or ISA local buses.

Bus mastering: allows peripheral devices and IDEs to access the system memory without going through the CPU (similar to DMA channels).

Cache: a temporary storage area for data that will be needed often by an application. Using a cache lowers data access times, since the needed information is stored in the SRAM instead of in the slow DRAM. Note that the cache is also much smaller than your regular memory: a typical cache size is 512KB, while you may have as much as 1GB of regular memory.

Cache size: refers to the physical size of the cache onboard. This should not be confused with the cacheable area, which is the total amount of memory which can be scanned by the system in search of data to put into the cache. A typical setup would be a cache size of 512KB, and a cacheable area of 512MB. In this case, up to 512KB of the main memory onboard is capable of being cached. However, only 512KB of this memory will be in the cache at any given moment. Any main memory above 512MB could never be cached.

Closed and open jumpers: jumpers and jumper pins are active when they are “on” or “closed”, and inactive when they are “off” or “open”.

CMOS (Complementary Metal-Oxide Semiconductors): chips that hold the basic startup information for the BIOS.

COM port: another name for the serial port, which is called as such because it transmits the eight bits of a byte of data along one wire, and receives data on another single wire (that is, the data is transmitted in serial form, one bit after another). Parallel ports transmit the bits of a byte on eight different wires at the same time (that is, in parallel form, eight bits at the same time).

DDR (Double Data Rate): improves RAM speed to at least 200 MHz. It activates output on both the rising and falling edge of the system clock rather than on just the rising edge, potentially doubling output.

DIMM (Dual In-line Memory Module): faster and more capacious form of RAM than SIMMs, and do not need to be installed in pairs.

DIMM bank: sometimes called DIMM sockets, because the physical slot and the logical unit are the same. That is, one DIMM module fits into one DIMM socket, which is capable of acting as a memory bank.

DMA (Direct Memory Access): channels that are similar to IRQs. DMA channels allow hardware devices (like soundcards or keyboards) to access the main memory without involving the CPU. This frees up CPU resources for other tasks. As with IRQs, it is vital that you do not double up devices on a single line. Plug-n-Play devices will take care of this for you.

Doze mode: in this mode, only the CPU's speed is slowed.

DRAM (Dynamic RAM): widely available, very affordable form of RAM which has the unfortunate tendency to lose data if it is not recharged regularly (every few milliseconds). This refresh requirement makes DRAM three to ten times slower than non-recharged RAM such as SRAM.

EDO RAM (Extended Data-Out RAM): speeds access to memory locations by assuming that memory addresses are static; the next time it looks for a bit of data, it will be at the same spot, or one nearby.

EEPROM (Electrically Erasable Programmable ROM): also called Flash BIOS, is a ROM chip which can, unlike normal ROM, be updated. This allows you to keep up with changes in the BIOS programs without having to buy a new chip. Tyan's BIOS updates can be found at <http://www.tyan.com>

ESCD (Extended System Configuration Data): a format for storing information about Plug-n-Play devices in the system BIOS. This information helps properly configure the system each time it boots.

Fault-tolerance: a term describing a system where one component can quickly be replaced without causing a loss of service, such as in a **RAID** system.

Firmware: low-level software that controls the system hardware.

Form factor: an industry term for the size, shape, power supply type, and external connector type of the Personal Computer Board (PCB) or motherboard. The standard form factors are the AT and ATX, although Tyan also makes some Baby-AT and ATX Footprint boards.

Global timer: onboard hardware timer, such as the Real-Time Clock (RTC).

Handshaking: a form of encryption. One system, typically the server, sends an encryption scheme to another agent, typically a client. Thus, the client's data is protected during transmittal to the server.

HDD: stands for Hard Disk Drive, a type of fixed drive.

H-SYNC: controls the horizontal synchronization/properties of the monitor.

IC (Integrated Circuit): the formal name for the computer chip.

IDE (Integrated Device/Drive Electronics): a simple, self-contained HDD interface. It can handle drives up to 8.4 GB in size. Almost all IDEs sold now are in fact Enhanced IDEs (EIDEs), with maximum capacity determined by the hardware controller.

IDE INT (IDE Interrupt): a hardware interrupt signal that goes to the IDE.

I/O (Input/Output): the connection between your computer and another piece of hardware (mouse, keyboard, etc.)

Initial Program Load (IPL): a feature built into BBS-compliant devices, describing those devices as capable of loading and executing an OS, as well as being able to provide control back to the BIOS if the loading attempt fails.

IRQ (Interrupt Request): an electronic request that runs from a hardware device to the CPU. The interrupt controller assigns priorities to incoming requests and delivers them to the CPU. It is important that there is only one device hooked up to each IRQ line; doubling up devices on IRQ lines can lock up your system. Plug-n-Play operating systems can take care of these details for you.

ISA (Industry Standard Architecture): a slower 8- or 16-bit bus (data pathway).

Latency: the amount of time that one part of a system spends waiting for another part to catch up. This is most common when the system sends data out to a peripheral device, and it waiting for the peripheral to send some data back (peripherals tend to be slower than onboard system components).

Mirroring: see **RAID**.

NVRAM: ROM and EEPROM are both examples of Non-Volatile RAM, memory that holds its data without power. DRAM, in contrast, is volatile.

OEMs (Original Equipment Manufacturers): Compaq or IBM package other companies' motherboards and hardware inside their case and sell them.

Parallel port: transmits the bits of a byte on eight different wires at the same time (that is, in parallel form, eight bits at the same time).

PCI (Peripheral Component Interconnect): a 32-bit local bus (data pathway) which is faster than the ISA bus. Local buses are those which operate within a single system (as opposed to a network bus, which connects multiple systems).

PCI PIO (PCI Programmable Input/Output) modes: the data transfer modes used by IDE drives. These modes use the CPU for data transfer (in contrast, DMA channels do not). PCI refers to the type of bus used by these modes to communicate with the CPU.

PCI-to-PCI bridge: allows you to connect multiple PCI devices onto one PCI slot.

Pipeline burst SRAM: a fast secondary cache. It is used as a secondary cache because SRAM is slower than SDRAM, but usually larger. Data is cached first to the faster primary cache, and then, when the primary cache is full, to the slower secondary cache.

Pipelining: improves system performance by allowing the CPU to begin executing a second instruction before the first is completed. A pipeline can be likened to an assembly line, with a given part of the pipeline repeatedly executing a set part of an operation on a series of instructions.

PM timers (Power Management timers): software timers that count down the number of seconds or minutes until the system times out and enters sleep, suspend, or doze mode.

PnP (Plug-n-Play): a design standard that has become ascendant in the industry. Plug-n-Play devices require little set-up to use. Novice end users can simply plug them into a computer that is running on a Plug-n-Play aware operating system (such as Windows 98), and go to work. Devices and operating systems that are not Plug-n-Play require you to reconfigure your system each time you add or change any part of your hardware.

Striping: see **RAID**.

RAID (Redundant Array of Independent Disks): a way for the same data to be stored in different places on many hard drives. By using this method, the data is stored redundantly, also the multiple hard drives will appear as a single drive to the operating system. RAID level 0 is known as striping, where data is striped (or overlapped) across multiple hard drives, but offers no fault-tolerance. RAID level 1 is known as mirroring, which stores the data within at least two hard drives, but does not stripe. RAID level 1 also allows for faster access time and fault-tolerance, since either hard drive can be read at the same time. RAID level 0+1 is both striping and mirroring, providing fault-tolerance, striping, and faster access all at the same time.

RAM (Random Access Memory): technically refers to a type of memory where any byte can be accessed without touching the adjacent data, is often used to refer to the system's main memory. This memory is available to any program running on the computer.

ROM (Read-Only Memory): a storage chip which contains the BIOS; the basic instructions required to boot the computer and start up the operating system.

SDRAM (Synchronous Dynamic RAM): called as such because it can keep two sets of memory addresses open simultaneously. By transferring data alternately from one set of addresses and then the other, SDRAM cuts down on the delays associated with non-synchronous RAM, which must close one address bank before opening the next.

Serial port: called as such because it transmits the eight bits of a byte of data along one wire, and receives data on another single wire (that is, the data is transmitted in serial form, one bit after another).

SIMM (Single In-line Memory Module): formerly the most common form of RAM for motherboards. They must be installed in pairs, and do not have the carrying capacity or the speed of DIMMs.

SIMM bank/socket: SIMM sockets are the physical slots into which you install SIMM modules. A pair of SIMM sockets form a SIMM bank, and act as one unit. If only one socket is filled, the bank will not operate.

Sleep/Suspend mode: in this mode, all devices except the CPU shut down.

SRAM (Static RAM): unlike DRAM, this type of RAM does not need to be refreshed in order to prevent data loss. Thus, it is faster, and more expensive.

Standby mode: in this mode, the video and fixed disk drive (usually the HDD) shuts down; all other devices continue to operate normally.

UltraDMA/33/66/100: a fast version of the old DMA channel. UltraDMA is also called UltraATA. Without the proper UltraDMA controller, your system cannot take advantage of the higher data transmission rates of the new UltraDMA/UltraATA HDDs.

USB (Universal Serial Bus): a versatile port. This one port type can function as a serial, parallel, mouse, keyboard, or joystick port. It is fast enough to support video transfer, and is capable of supporting up to 127 daisy-chained peripheral devices.

VGA (Video Graphics Array): the PC video display standard.

V-SYNC: controls the vertical properties of the monitor.

ZIF socket (Zero Insertion Force socket): these sockets make it possible to insert CPUs without damaging the sensitive CPU pins. The CPU is lightly placed in an open ZIF socket, and the metal level is pulled down. This shifts the processor over and down, guiding it into place on the board.



Notice for the USA

Compliance Information Statement (Declaration of Conformity Procedure) DoC
FCC Part 15: This device complies with Part 15 of the FCC Rules.

Operation is subject to the following conditions:

- 1) this device may not cause harmful interference, and
- 2) this device must accept any interference received including interference that may cause undesired operation. If this equipment does cause harmful interference to radio or television reception, which can be determined by turning the equipment off and on, the user is encouraged to try one or more of the following measures:
 - Reorient or relocate the receiving antenna.
 - Increase the separation between the equipment and receiver.
 - Plug the equipment into an outlet on a circuit different from that of the receiver.
 - Consult the dealer or an experienced radio/television technician for help.

Notice for Canada

This apparatus complies with the Class B limits for radio interference as specified in the Canadian Department of Communications Radio Interference Regulations. (Cet appareil est conforme aux normes de Classe B d'interférence radio tel que spécifié par le Ministère Canadien des Communications dans les règlements d'interférence radio.)



Notice for Europe (CE Mark)

This product is in conformity with the Council Directive 89/336/EEC, 92/31/EEC (EMC).

CAUTION: Lithium battery included with this board. Do not puncture, mutilate, or dispose of battery in fire. Danger of explosion if battery is incorrectly replaced. Replace only with the same or equivalent type recommended by manufacturer. Dispose of used battery according to manufacturer instructions and in accordance with your local regulations.

Document # D1446-100